



FUEL PUMPS

ČRPALKE ZA GORIVO
POMPE CARBURANTE
KRAFTSTOFFPUMPEN
POMPE DU CARBURANT





**Membranske črpalke za napajanje
motorjev z nafto ali bencinom**
*pompe a diaframma per il combustibile, per
l'alimentazione dei motori diesel o benzina*
*diaphragm fuel pumps for feeding
diesel or gasoline motors*
*Kraftstoffmembranpumpen
für diesel und benzin motoren*

PTZ d.o.o.

**Proizvodnja trgovina zastopništvo - proizvodnja
membranskih črpalk za gorivo in hladilno tekočino**
*produzione commercio rappresentanza - produzione
pompe a diaframma per il combustibile per motori e liquidi refrigeranti*
*production trade representation - production of
diaphragm fuel pumps and cooling liquids*
*produktion handlung vertretung - membranpumpen
produktion für kraftstoffe und küelflüssigkeit*

Program of:

PTZ



diesel

*cars
combi
compressors
tractors
motocultivators
marine machines*



benzin

*cars
combi*



Water

*circular saw
hachsaw*

fuel pumps for vehicles

PTZ



Installation of fuel pumps

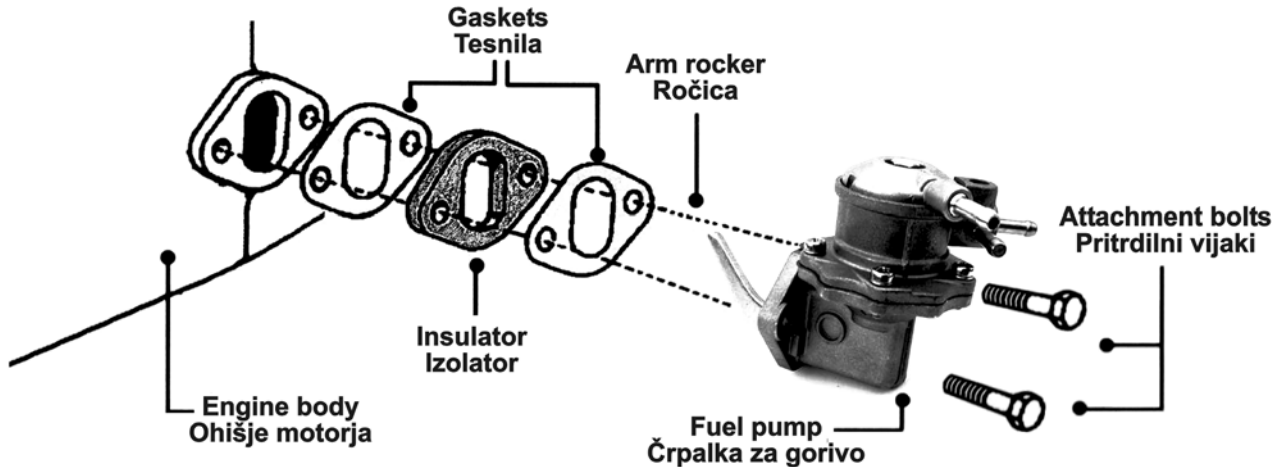

Be shure to install insulator

Starting the engine without installing the insulator will immediately damage the rocket arm and may result in the fuel pump or in the engine being permanetly damaged.

We will not accept responsibility for any damage couosed by fitting the pump without using the insulator. Eccentric lobe on camshaft should be furthest away from pump lever when fitting new pump.

WARNING! Hand turn engine only

Montaža izolatorja

Zagon motorja brez montaže izolatorja lahko trajno poškoduje črpalko ali motor.

Ne sprejemamo odgovornosti za poškodbe, ki so nastale zaradi napačne montaže bencinske črpalke.

OPOZORILO! Ročni zagon motorja

Montaža izolatora

Pokretanje motora bez izolatora može dovesti do trajnog oštećenja pumpe ili motora.

Ne preuzimamo odgovornost za oštećenja, koja su nastala zbog pogrešne montaže pumpe za benzin.

UPOZORENJE! Ručno pokretanje motora.



removal & installation of fuel pumps

A common cause of pump failure is OIL CONTAMINATION, which is caused by blockage of the engine breather filter. Is there is any sign of oil contamination clean or replace the engine breather filter before fitting a new fuel pump. Failure to do so will invalidate the warranty. To ensure a perfect fitment of the new fuel pump, the following instructions must be adhered to:

1 check that the new pump you are about to fit is the correct replacement for the old one!

2 general instructions:
always examine the mounting of the old pump before dismantling the pump and fuel lines, make sure that the insulator spacer (a) and the gaskets (b) if originally fitted are reassembled or replaced. there may be a few exceptions where the casting has been modified to make the refitting of the spacer unnecessary. please compare the old pump and spacer with the new pump to be certain.
failure to do so will cause damage to both the fuel pump and the engine, therefore take care, often the spacer remains stuck to the old unit and must be recovered and refitted to the new pump, if necessary.

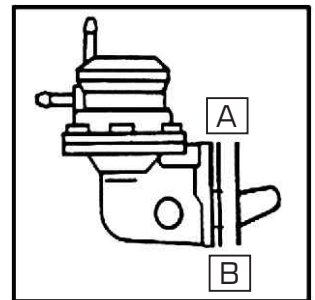

3 fitting 'plunger' type fuel pump:
you must check the position of the cam before fitting the new fuel pump.
the correct position of the cam drive lobe for pump installation is either top dead centre or bottom dead centre. see illustration!
fitting 'plunger' type fuel pump
you must check the position of the cam before fitting the new fuel pump.
the correct position of the cam drive lobe for pump installation is either top dead centre or bottom dead centre. see illustration!

fitting 'lever' type fuel pump:
ensure that when fitting the new pump that the lever arm is located on top of the camshaft eccentric, then push the pump into the studs.
you must check the position of the cam before fitting the new fuel pump.
the correct position of the cam drive lobe for pump installation is either top dead centre or bottom dead centre. see illustration!

once the pump is correctly positioned (plunger and lever type)
proceed as follows;

4 before tightening the bolts, always ensure that a spring washer is inserted between the bolt heads and the top of the mounting flange as this is recommended by the vehicle manufacturers

5 tighten the bolts gradually and alternately in order that the fuel pumps sits square to the mounting hole.
this operation is critical. if not adhered to, the mounting plate or flange may become deformed causing the push rod or level itself to move off centre causing these to break or eject the spring and retainer upon initial engine start up.

6 check that the mounting is right. reconnect the fuel lines, ensuring that all connections are tight and secure and leakproof.

the pump is now ready to operation.

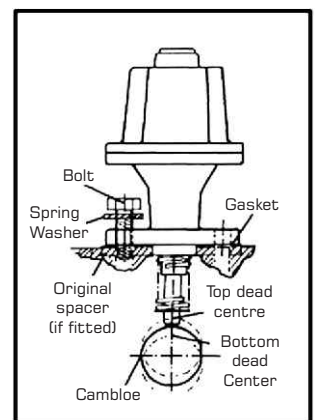



Alphabetical list of pumps

fuel pumps for vehicles

PUMP	PTZ number	page
------	------------	------

ALFA ROMEO

2000	3003	24
1750, 2000	3002	24
33 1300 - 1600	3449	53
33, 33 S	3007	24
75 (TUTTI I TIPI)	3002	24
A 11 - A 12 FURGONE	3002	24
ALFETA 2000, ALFA 90	3008	24
ALFETTA	3002	24
ARNA (TUTTI I TIPI)	3007	24
F 11 - F 12 FURGONE	3002	24
GIULIA GT, TI SUPER	3002	24
GIULIETTA	3002	24
GIULIETTA 1300, 1600, 1800	3008	24
SPIDER	3002	24
SUD BERLINA - TI	3006	24
SUD SPRINT, VELOCE	3007	24
SUD, TI	3007	24

AUDI

50	4376	67
60	4376	67
80	3373	42
80	3373	42
80	4376	67
(5 CIL. - 1900 CC - 100 HP)	4551	90
100 - C - CLCS - GL - AVANT	4585	95
100 - CC - CS - CD - AVANT	4551	90
100 (5 CIL.) 77	4549	90
100 2000 (115 PS)	4375	67
100 AVANT	3373	42
100 AVANT CC, CS, CD	3469	55
100 C, CL, CS, GL	3373	42
100 C, CL, CS, GL	3469	55
100 MOT. 1800	4378	67
100/1800 - 1900 12/68 - 7/76	4459	77
60/1500 2/68 - 7/72	4459	77
70/1700 11/68 - 7/72	4459	77
80 C, CL, GL COUPE	3373	42
80 C, CL, GL COUPE	3469	55
80 COUPE GLS	3373	42
80 GLS	3469	55
80 LD (1900 CC - 100/115 HP)	4551	90
80, 100	3373	42
90/1800 12/55 - 8/71	4459	77
COUPE	3373	42
COUPE	3469	55
COUPE GT 5 S 10/80 - 07/81	4589	96
COUPE GT5S (1900 CC - 115 HP)	4551	90

AUSTIN - ROVER

LIGHT COMMERCIAL MAESTRO VEN 2,0 D	3490	58
MONTEGO 1,6	3490	58

AUTOBIANCHI

A 112 1 A SERIE (2 TUBETTI PICCOLI)	3018	25
A 112 ABARTH	3019	25
A 112 R77, R79, R82	3020	25
Y 10 4 WD - FL 89; FIRE 1000	5000	104
Y 10 TOURING, TURBO	3019	25

BARKAS

100 1300 CC. VAG	4600	98
------------------	------	----

PUMP	PTZ number	page
------	------------	------

BEDFORD

BEAGLE ESTA TE CAR	3382	43
CHEVANNE	3386	43
CHEVANNE 76	3446	52
HA FURGANE B/8 CWT.	3382	43

BMW

315	4572	93
316	4500	84
316	4572	93
316	4582	95
320	4500	84
518	4500	84
1502	4492	82
1602	4492	82
1802	4492	82
2002	4492	82
1500 (80 HP) 59 - 1/65	4223	61
1500/1800	4222	61
1600 (83 HP) 59 - 4/64	4223	61
1602 - 1600 (85 HP) 3/66 - 7/73	4223	61
1800 (90 HP) 63 - 9/72	4223	61
1800 MOT. MARINO (90 HP) 4/66	4223	61
1800 TL (110 HP) 64 - 7/68	4224	61
1802 - 1800 (90 HP) 9/70 - 7/73	4223	61
2000 AUT. (100 HP) 66 - 9/72	4224	61
2000 MOT. MARINO (100 HP) 1/68	4223	61
2000 TL (120 HP) 8/65 - 7/71	4224	61
2002 - 2000 (100 HP) 1/68 - 8/73	4224	61
2002 AT (USA)	4492	82
2500 (150 HP) 9/68 - 1/77	4225	61
2800 (170 HP) 9/68 - 1/77	4225	61
3000 (180 HP) 4/71 - 1/77	4225	61
318, 318 AT	4500	84
320, 320 AT	4493	83
3300 (190 HP) 7/74 - 9/75	4225	61
518 + AT	4582	95
518, 518 AT	4572	93
520, 520 AT	4493	83
520, 520 AT	4500	84
525, 525 AT	4501	84
525/2500 (145 HP) 9/73 - 6/76	4225	61
528, 528 AT	4501	84
528/2500 (165 HP) 2/75 - 6/76	4225	61
630 CS/AT	4501	84
700 - MOD. 107/32 HP DAL 59	4220	61
700 - MOD. 107/40 HP DAL 61	4221	61
728, 728 AT	4501	84
730, 730 AT	4501	84
MARINO	4492	82

BRITISH LEYLAND

1100 - 1300 - 1300 GT - MK2, 3 67 - 74	3435	51
12V/L17315, VAN 71 - 80	3435	51
18V/E/L16556 - 18V/E/H15786 71 - 78	3461	54
2V/L1731671 - 80	3436	51
AUSTIN (18/22 SERIE) 1800 75	3447	52
AUSTIN 10 CWT VAN ECE 1300	3424	49
AUSTIN 1800 MK 2,3 A 'S' 68 - 75	3447	52
AUSTIN ALLEGRO 1000/1100/1300 73	3436	51
AUSTIN ALLEGRO 1100/1300 - AUSTIN 7...	3424	49

PUMP	PTZ number	page
------	------------	------

AUSTIN ALLEGRO 1500/1750	3456	54
AUSTIN ALLEGRO 1500/1750 - HL - SPOR...	3423	49
AUSTIN ALLEGRO METRO	3432	50
AUSTIN LM 11	4532	88
AUSTIN MARINA 7 CWT 1100 VAN 72 - 78	3436	51
AUSTIN MARINA 7/10 CWT DAL ...	3436	51
AUSTIN MAXI 1500 - 1750 - HL 69 - 82	3434	50
AUSTIN MINI ECE	3422	49
AUSTIN MORRIS LM 10 4 E	4530	88
AUSTIN ROVER MAESTRO MONTEGO 1, 3	3477	56
AUSTIN ROVER MONTEGO 2.0 LITRI	4568	93
AUSTIN SERIE MARINE MAESTRO 1600	4529	87
AUTOMATIC 1800 S 68 - 75	3389	44
INNOCENTI REGENT 1500	3456	54
L. HLS. MAESTRO 3/83	4529	87
LEYLAND MINI 850/1000/1100 - CLUBMAN...	3435	51
LEYLAND PRINCESS 1800 75 - 78	3447	52
LEYLAND SHERPA 1622/1798 CC. 74 - 78	3461	54
METRO 100/1300 80	3435	51
MG 1300 67 - 71	3435	51
MINI 1100 75	3425	49
MINI 850/1000/1100 - CLUBMAN - VAN...	3435	51
MINI CLUBMAN 100 - 1275 GT 69 - 71	3425	49
MINI MK II 850/1000/1100/1300 69	3425	49
MINI MK III 1100/1300 71 - 76	3425	49
MORRIS (18/22 SERIE) 1800 75	3447	52
MORRIS 1.3-MINOR 850-1.1 BE-1275-1.3	3380	42
MORRIS 1100/1300/1300 GT - MK 2,3 ...	3435	51
MORRIS 1800 MK 2,3 E 'S' 68 - 75	3447	52
MORRIS 185-215-220 ...	3387	44
MORRIS ITAL 1300 80	3436	51
MORRIS ITAL 1300 A VAN 80	3435	51
MORRIS MARINA 1,3 DAL MOT. 12V/H29475	3435	51
MORRIS MARINA 1,8-1,8 TC DA MOT. N 18...	3461	54
MORRIS MARINA 1300 DA MOT. N. 12V...	3436	51
MORRIS MARINA 1700 - ITAL 1700/2000	4515	85
MORRIS MARINA 1800 - TC - AUTOMATIC	3387	44
MORRIS MARINA 7 CWT 1100 VAN 72 - 80	3436	51
MORRIS MINI 850/100/1100 - CLUBMAN...	3435	51
PRINCESS 1.8 - AUTO. - MK II - 1.8 MK II	3389	44
PRINCESS 1500	3456	54
PRINCESS 2200 AUTOMATIC 75	3392	44
PRINCESS 2200 AUTOMATIC 75	3392	44
RILEY KESTREL 1100/1300 67 - 69	3435	51
SHERPA 185 - 215 - 220 - CV 215 240 - 306	3387	44
SHERPA F. 7, 2.0 PETROL OHC	4556	91
SHERPA SERIE OHC 78 - 80	4515	85
TRAVEL ALLEGRO 1100/1300	3380	42
VAN 71 - 78	3387	44
VANDEL PLAS 1300 67 - 74	3435	51
WOLSELEY 1300 67 - 73	3435	51

BUKH

INDUSTRIALE TALBOT 1973	3289	35
-------------------------	------	----

CHRYSLER

DODGE OMNI	4446	75
K CAR USA (2600 CC 4 GS ENG.)	4467	78
PEYCAN	4521	86
PLYMOUTH HORIZONTH	4446	75
	4447	75



PUMP	PTZ number	page
	4471	79
CITROEN		
2 CV	3240	31
2 CV 4, 2 CV 6, 2 CV SPECIAL	3241	32
2 CV CLUB, 2 CV CHARLESTON	3241	32
2 CV FOURGONETTE AZU	3240	31
3 CV A C8 (SPAGNA)	3335	40
3, 4 CV	3241	32
ACADIANE	3241	32
AKB, AK400	3241	32
AMI 6, 8	3241	32
AMI 8 SUPER	4242	62
AX 10 E, 10 RE, THE	3485	57
AX 10, 11, 14	3485	57
AX 14 TZS	3485	57
AX, 11 TRE	3485	57
AXEL	3241	32
AXEL "12 R"	4242	62
AXEL EXPORT	3241	32
AXEL, SPECIAL	3241	32
AZEL "11 R"	4242	62
BX 11	3485	57
BX 14	3485	57
BX 14 (TUTTI I TIPI)	3293	36
BX 15, 16, 19, RS, TRS	4562	92
BX 16 (TUTTI I TIPI)	3293	36
BX 16 OHC 1/92 - 12/93	4620	100
BX 16 OHC 9/89 - 12/91	4618	100
BX 19 GT	4562	92
BX 19 OHC 1/92/ - 6/94	4620	100
BX 19 OHC 9/89 - 12/91	4618	100
BX 19 SPORT	4575	94
BY 15, 16, 19	4575	94
C 15	3293	36
C 15 VAN	3485	57
C 25	4291	64
C 25 1800, 2000	3291	35
C 35	4246	62
C 35 1985 9/73 - 1977	3243	32
CX	4246	62
CX 20, 20 THE	4537	88
CX 22 TRS	4537	88
CX REFLEX, ATHENA	4537	88
CX TRS	4537	88
D SPECIAL, D SUPER, D SUPER 5...	3243	32
DS 20 - 9/73 - 1975, DS 23 CARB...	3243	32
DYANE (LUXE A CONFORT)	3240	31
DYANE 4, 6	3241	32
ERFTREPRISE	4242	62
FOURGONETTES, AZU, AK, AKB	3241	32
GS 1 OL 5, GS 1220, GS X3	4242	62
GS, GSA, GX, GSX	4242	62
GSA SPECIAL, BREAK SPECIAL	4242	62
LN E, RE	3293	36
LN, LNA	3241	32
MEHARI	3241	32
MEHARI A 4 x 4	3241	32
VISA (TUTTI I TIPI)	3293	36
VISA SPECIAL CLUB	3241	32

PUMP	PTZ number	page
VISA SUPER GT	3293	36
VISA, VISA II SPECIAL	3241	32
XM 2.0 OHC 112/91 - 92	4620	100
XM 2.0 OHC 9/89 - 12/91	4618	100
XM 21	4562	92
ZX	4562	92
ZX 10, 11, 14	3485	57
DACIA (ROMANIA)		
1210, 1310, 1320	3312	38
1410	3312	38
DAEWO		
TICO	4611	99
DAIHATSU		
CHAMANT 1.3 OHV	4625	100
DATSUN - NISSAN		
(1600/2100 CC. - L16/L18/L20 ENG.)	4442	74
120 Y - A 14	4427	72
1200 B100 Ute A12 1971-85	4482	81
120V - A14	4428	72
140 J, VIOLET (MOT. A 14)	4545	89
140 Y, SUNNY (MOT. A 14)	4545	89
510 SEDAN & WAGON - 2000 ENG.	4470	79
510 SEDAN WAGON - 2000 ENG.	4437	74
610 SEDAN ER WAGON - 1800 ENG.	4543	89
620 PICK - UP - 2000 ENG.	4436	73
620 PICK - UP (L 20 B ENG.)	4435	73
620 SX - L 20 B - 2000 ENG.	4437	74
710 SEDAN & WAGON - 2000 ENG	4436	73
B 210 SEDAN & COUPE - 1400 ENG.	4475	79
BLUEBIRD 521 - EXP. 1400/1600 CC...	4441	74
BLUEBIRD K 610 - TRUCK 620	4442	74
CHERRY 1.0 (N 12) (E 10 ENG.) OHC	4590	96
CHERRY 1.0 (N 12) (E 10 ENG.) OHC	4592	96
CHERRY 1.3 (N 12) (E 13 ENG.) OHC	4587	96
CHERRY 1.3 (N 12) (E 13 ENG.) OHC	4590	96
CHERRY 1.5 (N 12) (E 15 ENG.) OHC	4587	96
CHERRY 1.5 (N 12) (E 15 ENG.) OHC	4590	96
CHERRY EUROPE 1.2, 1.5 (920)	4588	96
CHERRY, E 10 - F 10 (MOT A 10)	4546	89
MICRA 1.0 (K 10) (MA 10 ENG.) OHC	4592	96
MIKRA (1000 CC - MA 10 ENG.)	3575	60
MIKRA CANADA (1200 CC. - MA 12 ENG.)	3574	60
NISSAN	4460	77
NISSAN	4469	78
NISSAN	4485	81
NISSAN 1100/1200 ENG. 70	4439	74
NISSAN 120 Y, DL, SDX 1200 ENG. 75/80	4559	91
NISSAN CHERRY A 12 74 - 78	4486	81
NISSAN FAIRLADY R 16 65 - 67	4483	81
NISSAN FAIRLADY U 20 67	4484	81
NISSAN FL 10/ A 14	4454	76
NISSAN SUNNY B 10/A12 70 - 74	4482	81
NISSAN TRUCK H 20 70 - 75	4499	84
PICK - UP TRUCK 620 J 15 75	4427	72
PICK-UP TRUCK 620 1975	4429	72
PRAIRIE 1.5 (M 10) (E 15 ENG.) OHC	4590	96
SKYLINE T 230 - K 230	4604	98
SUNNY (1200/1500 CC - A12/14/15 ENG.)	4475	79
SUNNY 1.3 (B 11) (E 13 S ENG.) OHC	4587	96

PUMP	PTZ number	page
SUNNY 1.3 (B 11) (E 13 S ENG.) OHC	4590	96
SUNNY 1.5 (B 11) E 15 S ENG.) OHC	4590	96
SUNNY 1.6 (B 12, N 13) (E 16 ENG.) OHC	4598	97
SUNNY VAN 1.3 (B 11) (E 13 S ENG.) OHC	4590	96
FENWICK		
CARELLI ELEVATORI	4509	85
CROMA	4629	101
FIAT		
132	3078	29
132	3204	31
(1100 CC) - UNO 70 (1300 CC) - REGATA...	3060	27
(1100/1300 CC) 128 3P - RITMO, UNO 55...	3060	27
(LEVA CORTA) ~ 6/67	3063	28
1100 D/R, 1200	3024	26
1100 T	3265	33
1100 T4, 238 E, 238 B	3023	26
1100/103, 1100 ABE	3024	26
124 BN. 1.2 CC - FAMILIARE...	3064	28
124 BN. 1.2 CC - FAMILIARE-COUPÉ-SPYDER	3063	28
124 SPECIAL T (1600 CC.)	3393	44
124 SPECIAL T 1600 CC	3065	28
124 SPECIAL T MOD. U.S.A. (1600 CC.)	3086	30
124 SPECIAL T USA	3067	28
124 SPECIAL T USA	3203	31
124 SPORT - SPYDER - COUPE 1600 CC	3066	28
124 SPORT (1800 CC.)	3393	44
124 U.S.A. COUPS & SPIDER (1800 CC.)	3393	44
124 USA COUPE - SPYDER	3078	29
124 USA COUPE - SPYDER	3204	31
125 BN. 2A SERIE - SPECIAL (LEVA LUNGA)	3069	28
126 BIS 704	3476	56
126 BIS C/MOT. 704	3076	29
126 C/DINAMO 600	3021	26
126, 126 PERSONAL (C/ALTERNAT) 650...	3082	30
127 (TUTTI I TIPI)	3019	25
127, FIORINO	3020	25
128 - 128 FAMILIARE 1 A SERIE...	3059	27
128 2A SERIE-FAMILIARE-RALLY-SPECIAL...	3060	27
1300, 1500, 1800, 2300	3070	29
131 - 1365, 1600 MIRAFIORI CL 5/81	3440	51
131 81 - 82	3470	55
131 ABARTH RAILY	3078	29
131 ABARTH RAILY	3204	31
131 BRAVA U.S.A. (1800 CC.)	3393	44
131 FL	3441	51
131 MONDALBERO	3414	47
131 RACING	3078	29
131 RACING	3204	31
131 SUPERMIRAFIORI	3078	29
131 SUPERMIRAFIORI	3204	31
131 TC SUPERMIRAFIORI (1300 - 1600 CC.)	3393	44
131 USA SUPERBRAVA	3078	29
131 USA SUPERBRAVA	3204	31
132 BN - 132 SPECIAL (1600 CC.)	3393	44
132 BN. - SPECIAL - GLS 1600/1800	3065	28
132 BRI - 132 SPECIAL (1800 CC.)	3393	44
132 GLS (1600 - 1800 CC.)	3393	44
132 L	3407	46
132/2000	3415	48

PUMP **PTZ** **page**
number

1400 - 1900	3071	29
242, 242 E, 242 E.F.I.	3083	30
500 (TUTTI I TIPI) -	3021	26
500 GIARDINIERA	3022	26
850 (TUTTI I TIPI)	3056	27
ARGENTA	3078	29
ARGENTA	3204	31
CINQUECENTO 700	4628	101
CINQUECENTO 900 CARBURATORE	5001	104
COMPAGNOLA TORPEDO 6132A162 BENZIN	3084	30
DUNA 60, 70	3019	25
FIORINO, PICK-UP	3019	25
FURGONE, PULMINO 850	3056	27
LIGHT COMMERCIAL UNO VAN 1,0 OHV	3442	51
PANDA 1000 SUPER, 4 X 4, SISLEY; 1000	5000	104
PANDA 30 (TUTTI I TIPI) 650	3397	45
PANDA 45, 4X4	3020	25
PANDA 750 CL	3495	59
PANDA 750 SUPER	3495	59
PANDA 750 YOUNG	3495	59
PANDA DANCE	3495	59
PANDA; FIRE 750, 1000	5000	104
REGATA 100 S 83	3474	56
REGATA 100 V. 7056786 - 7380450	3416	48
RITMO 100 S ... VETT. 4880206	3416	48
RITMO 105 TC	3416	48
RITMO 105 TC CON COND. 03/83	3085	30
RITMO 130 TC	3078	29
RITMO 130 TC	3204	31
RITMO 60 L	3019	25
RITMO 75 L - GL (SWEDEN)	3085	30
RITMO SUPER CONDIZIONATA	3085	30
STRADA U.S.A. (RITMO U.S.A.) CARB	3085	30
TEMPRA (CARBURATORE)	3478	57
TIPO, TIPO DGT/AGT (CARBURATORE)	3478	57
TIPO, TIPO DGT; 1100	5000	104
UNO 45 (TUTTI I TIPI)	3070	29
UNO 45 INCL. ENERGY SAVING ENG. 903	3442	51
UNO R 89 STING	3070	29
UNO R 89; FIRE 1000, 1100	5000	104
UNO R89	3478	57
UNO; FIRE 1000	5000	104
X1/9 (1300 CC)	3062	27
X1/9 U.S.A. (1500 CC)	3062	27

FIAT (ARGENTINA)

1100, 1100 D	3024	26
600, 600 D -	3021	26
DUNA	3019	25
EUROPA	3019	25
REGATTA 85 WEEKEND	3019	25
SPAZIO	3019	25
UNO	3019	25

FIAT (BRASILE)

147 PANORAMA, PICK-UP	3019	25
ELBA	3019	25
PREMIO	3019	25
UNO CS, R	3019	25
UNO MILLE	3019	25
FIAT FURGONI		

PUMP **PTZ** **page**
number

238 A - 1100 T MOT. 217	3151	30
FORD		
(GB) VETURRE	3243	32
(HCS) 3 TUBES 08/89 - 08/90	4700	101
(HCS) MAN 2 TUBES	3589	60
(HCS) MAN. 2 TUBES	3589	60
2600 (4 CIL. ENG.)	4450	75
5/7 CWT ANGLIA	3261	33
6/8 CWT ESCORT	3261	33
95 - 96 SPORT MOT. FORD	4404	68
ANGLIA	3261	33
ANGLIA 65 - 67	3243	32
ANGLIA OHV	3262	33
CAPRI 1.3/1.5/1.7 (4 V) - CONSUL 1.7...	4288	64
CAPRI 1300 - 1600	3262	33
CAPRI 1300 - 1600 AUTO	3262	33
CAPRI 1300 GT - 1600 GT	3262	33
CAPRI 1300 GT/1600 GT 69 - 1 /74	3243	32
CAPRI 1300/1500/1700	4284	63
CAPRI 1300/1500/1700 (4V) OHV 67-71	4283	63
CAPRI 1300/1600 19/67 - 7/69	3243	32
CAPRI 1300-1600 4CYL. 4/70	4283	63
CAPRI 2000/2300/2600	4404	68
CAPRI 2800	4474	79
CAPRI 2800 (6/V) USA 2/74	4526	87
CAPRI 3000	4425	72
CAPRI ARIZONA 2800 (6/V) USA 4/73 - 5/75	4526	87
CAPRI USA	4523	87
CAPRI, CAPRI GT	3261	33
CONSUL 1700-TRANSIT 1.2/1.3/1.5/1.7 ...	4284	63
CONSUL 2000 4CYL. 90HP 4/1970-8/79	4283	63
CONSUL 2000 V 4 - 2500 - 3000	4425	72
CONSUL 2300 - TANUS 2000/2300/2600	4404	68
CORSAIR V 4	4450	75
CORSAIR V 4	4451	75
CORTINA	3261	33
CORTINA 1600-2000 4CYL. 1977	4283	63
CORTINA 2000(USA) 1971-8/82	4283	63
CORTINA LOTUS	3261	33
CORTINA MK I - 1200 - 1500	3262	33
CORTINA MK I - 1300 - 1500	3262	33
CORTINA MK II - 1300 - 1600	3262	33
CORTINA MK2 - MK3 - MK4	3261	33
CORTINA MK3 1600-2000 GT OHC 1970-76	4283	63
CORTINA MKI 1200/1300/1500 65 - 67	3243	32
CORTINA TC,TD,TE,TF 2000 1971-81	4283	63
COUPE DOVER DIESEL	4612	99
COURIER UA, UE, UF FE, F2	4730	103
COURIER VAN 1.1, 1.3 OHV	4579	94
ECONOVAN & MAXI F8, FE	4730	103
ECONOVAN FE	4730	103
ESCORT	3261	33
ESCORT	3486	58
ESCORT	3486	58
ESCORT 1976-82	4283	63
ESCORT - FIESTA - ORION 1300/1600	4516	86
ESCORT 1.3 OHV	4579	94
ESCORT 1.4 CVH	4584	95
ESCORT 1.6 CVH	4584	95

PUMP **PTZ** **page**
number

ESCORT 1100 - 1300 GT	3262	33
ESCORT 1100-1300-1600 4CYL. OHC 9/1980	4283	63
ESCORT 1300	3262	33
ESCORT 1300 68 - 69	3260	32
ESCORT 1400 - 1600 CVH	4581	95
ESCORT M K IV, V 1.1, 1.3 OHV	3589	60
ESCORT MKV 1.1, 1.3 OHV	4581	95
ESCORT VAN 1.6 CVH	4584	95
ESCORT XR3 1982	4283	63
ESCORT, ESCORT GT	3261	33
ESCORTD VAN 1.4 CVH	4584	95
FALCON	4554	91
FESTIVA WA B3 1.3 1991-94	4703	101
FIESTA	3261	33
FIESTA	3486	58
FIESTA	3486	58
FIESTA 1.0 OHV	4579	94
FIESTA 1.1 OHV MANUAL	4579	94
FIESTA 1.3 OHV	4579	94
FIESTA 1.3, 1.1, 1.3 OHV	4579	94
FIESTA 1.4 CVH	4584	95
FIESTA 1.6 CVH	4584	95
FIESTA 1000-1100-1300 4CYL. OHC 1976	4283	63
FIESTA 1400 - 1600 CVH	4581	95
FIESTA MK III 1.1, 1.3 OHV	3589	60
FIESTA MK IV, V 1.1, 1.3 OHV	4700	101
FIESTA U.S.A.	3296	37
FIESTA VAN 1,3 OHV	4579	94
FIESTA XR2 1600 OHC 4/1984	4283	63
FIESTA XR2, OHV	3261	33
FORD LASER KF, KH B6	4751	104
GRANADA 1700 (70/75 HP) (4 V) 1/72	4288	64
GRANADA 2000 9/1979	4283	63
GRANADA 2000 V 4 - 2500 V 6 - 3000 V 6	4425	72
GRANADA 2000/2300/2600	4404	68
GRANADA, SIERRA 2.0 OHC 1984 ON	4558	91
HOLDEN	4555	91
KENT MARINA, 105 E	3261	33
LASER KA, KB 1981-85	4607	98
MUSTANG 2800 (6/V) USA 4/73	4526	87
ORION	3486	58
ORION	3486	58
ORION 1.3 OHV	4579	94
ORION 1.4 CVH	4584	95
ORION 1.6 CVH	4584	95
ORION 1300-1600 OHC 9/1983-8/88	4283	63
ORION 1400 - 1600 CVH	4581	95
PINTO 2800 (6/V) USA 6/75	4526	87
SCORPIO 1800-2000 OHC 4/1985	4283	63
SIERRA 1600-1800-2000 4CYL. ...	4283	63
SPECTRON F8, FE	4730	103
TAUNUS 12M	3287	35
TAUNUS 12M - 15M - 17M 1A SERIE	3280	34
TAUNUS 12M 1200	3287	35
TAUNUS 12M 1500	3287	35
TAUNUS 12M 1700 1967-70	4282	63
TAUNUS 12M 17M 1200/1500/1700 60-63	3281	34
TAUNUS 12M mot.2000 6CYL. 1964-66	4282	63
TAUNUS 12M/15M 1200/1300/1500...	4282	63

PUMP	PTZ number	page
TAUNUS 1300-1600 4CYL. 4/1970	4283	63
TAUNUS 15M 1700 (70/75HP) 4V 67-71	4283	63
TAUNUS 1600 - 2600	4453	76
TAUNUS 17M - 20M 1800/2000 6CYL.	4284	63
TAUNUS 17M 1500/1700 1964-67	4282	63
TAUNUS 17M 4 CIL. 1700 57 - 68 ...	3286	35
TAUNUS 17M 4 CIL. 1700 59 - 60 ...	3281	34
TRANSIT	3261	33
TRANSIT (benzina) mot.1700 4CYL...	4282	63
TRANSIT 1500/1700 (4 V) 1/72 - 3/73	4288	64
TRANSIT 1600-2000 4CYL. OHC 4/1984	4283	63
TRANSIT 4V 1200/1500 60 - 64	3281	34
TUTTE CON MOTORE 6 CIL AV	4404	68
ZEPHYR 4 - 6 MK	4451	75
ZEPHYR 4 - 6 MK IV	4450	75
ZODIAC MK IV	4425	72
ZODIAC MK IV	4450	75
ZODIAC MK VI	4451	75
FORD (BRASILE)		
BELINA DEI REY, PAMPA	3469	55
BELINA, DEL REY, PAMPA	3373	42
ESCORT GHIA, XR - 3, VERONA	3469	55
ESCORT GHIA, XR-3, VERONA	3373	42
PAMPA	3469	55
ROYALE	3469	55
VERSAILLES	3469	55
FORD (GB)		
ESCORT 1600 OHC - RS 2000 - CONSUL...	4432	73
ESCORT 1600 CC	4445	74
FORD (USA)		
LASER KA - KB 1300 - 1500	4573	94
MATEOR GA - GB 1500	4573	94
FOX		
AUDI	3373	42
FSO (FIAT POLONIA)		
125 KOMBI	3070	29
125 P	3265	33
125 P - 1300/1500 POLONEZ 76	3340	40
POLONEZ ALIZE, AMPLIA, PRIMA	3070	29
POLONEZ MISTRAL, PRIMA	3070	29
POLONEZ PRIMA	3070	29
GHM, HOLDEN		
DROVER QB G13A	4739	103
GEMINI TE, TF, TG G161Z	4727	102
RODEO KB, KB21, 27, 28	4727	102
HILLMAN		
(TALBOT SIMCA - SUNBEAM) AVENGER ...	3453	53
1250 - 1500	3453	53
HUNTER PAYKAAN LO - LINE 1598	3453	53
HOLDEN		
TORANA SUBIRD 1900	4271	62
HONDA		
AL.AM.AG.AS.AH. AK.TOCH.NO 1008519...	4580	94
CIVIC (1237 CC)	4473	79
CIVIC (1300 CC)	4455	76
CIVIC 1.2 - 1.3 - 1.5 EXCL. INJ. SERIES	4580	94
CIVIC 1237 CC	4424	72
HYUNDAI		
PONY 1300 LS (G 13 B ENGINE)	4705	102

PUMP	PTZ number	page
PONY 1500 72 (G 15 B ENGINE)	4705	102
STELLAR 1,6	3492	58
INNOCENTI		
ELBA	3019	25
KORAL 45	3020	25
MINI 1001	3381	43
MINI, MINI 90, MINI 1275 GT	3381	43
ISUZU		
	4478	80
KIA		
PRIDE	4703/1	101
PRIDE	4703	101
LADA		
21043 STATION WAGON	3265	33
2105	3265	33
2105	4265	62
2107	3265	33
2107	4265	62
21043 STATION WAGON	4265	62
CARLOTA	4570	93
CARLOTA 1100, 1300, 1500	3570	59
NIVA	3265	33
NIVA	4265	62
SAMARA	4570	93
SAMARA 1100, 1300, 1500	3570	59
LADA (BRASILE)		
NIVA, LAIKA	3019	25
LANCIA		
APPIA I/II/III SERIE	3200	31
BETA (TUTTI I TIPI)	3067	28
BETA (TUTTI I TIPI)	3203	31
BETA 2 LT. 75 - 89	3475	56
BETA 200, COUPE	3078	29
BETA 2000 (USA - SVEZIA)	3417	48
BETA 2000, COUPE	3204	31
BETA COUPE	3067	28
BETA COUPE	3203	31
BETA COUPE HPE	3067	28
BETA COUPE HPE	3203	31
BETA HPE	3067	28
BETA HPE	3203	31
BETA TREVI	3067	28
BETA TREVI	3078	29
BETA TREVI	3078	29
BETA TREVI	3203	31
BETA TREVI	3204	31
BETA TREVI	3204	31
BETA USA, SVEZIA	3416	48
DELTA GT	3416	48
FLAVIA BN ...4/67	3202	31
FULVIA 2C - GT - HF - COUPE 1.3/1.6/2.0...	3201	31
HPE, MONTECARLO	3078	29
HPE, MONTECARLO	3204	31
PRISMA 1600	3445	52
PRISMA LX	3078	29
PRISMA LX	3204	31
PRISMS	3416	48
LOMBARDINI		
INDUSTRIALE LDA 90/2	3024	26

PUMP	PTZ number	page
LOTUS		
ELAN 1558, CORTINA	3261	33
SEVEN, SUPER SEVEN	3261	33
M. G.		
MIDGET 78	3406	46
MAZDA		
323 BF, B6 1.6 1985-89	4703	101
323 BG B6	4751	104
323 E3, E5 1980-85	4607	98
626 1.6 (GC 1)	4605	98
626 1.6 (GC 1)	4607	98
626 1.8 (GD 1)	4605	98
626 1.8 (GD 1)	4607	98
626 2.0 (CARB.) (GC 1)	4605	98
626 2.0 (CARB.) (GC 1)	4607	98
626 EXP. CAPELLA-TELSTAR(1800/2000 CC.)	4606	98
8181300 CC.-323 1000/1300-PICK-UP 1.6	4405	68
B2000 FE	4730	103
B2200 F2	4730	103
E1800 F8	4730	103
E2000 (INC 4x4) FE	4730	103
MERCEDES - BENZ		
280	4302	65
170 SV (52 HP) 52 - 53	3300	37
180 (52 HP) 7/53 - 57	3300	37
180 A (65 HP) 57 - 59 ...	4503	84
180 B - C (68 HP) 9/59 - 9/62	3300	37
190 - 190 B (75 HP) 4/56 - 7/59	3300	37
190 C - DC (80 HP) 3/61 - 7/65	3301	37
190/W120/M102 (2000 CC - 105 HP)	4553	90
190/W201/M102 (2000 CC - 90 HP)	4553	90
200 - 2000 (95 HP) 8/65 - 67	3301	37
200/8 - 2000 (95 HP) 1/68 - 1/71	3301	37
200/W123/M102 (2000 CC - 109 HP)	4553	90
200/W123-M115	4302	65
200/W124/M102 (2000 CC - 109 HP)	4553	90
219/220 A (85 HP) 7/51 - 7/65	3300	37
220 (80 HP) 220 A (100 HP) 4/56 - 7/59	3300	37
220 B (95 HP) - 220 SB (110 HP) 59 - 65	3300	37
220/8 (105 HP) 1/68 - 3/68	3301	37
230 G-M115	4302	65
230 S - 230/8 (120 HP) 9/59 - 1/71	3300	37
230, 230/6, 230/4, 230/W123	4302	65
230/4 USA	4460	77
250 S - 280/8 (140 HP) 1/68 - 12/70	3300	37
250, 250/W123	4302	65
280 S - 280/8 (140 HP) 1/68 - 12/70	3300	37
280/ W123	4302	65
280S	4302	65
319 B (65 HP) 57 - 9/61	3300	37
70 SB (52 HP) 50 - 52	4503	84
L 208, 308	4302	65
L 319 B	4302	65
L 319 B 1900 (68 HP) - L 319 B 2.0...	3301	37
L 408	4302	65
L 408 - 2200 (75 HP) 2200 (85 HP) 67 - 71	3301	37
L 409	4302	65
L 601	4302	65
UNIMOG L 404 S	4302	65

PUMP **PTZ** **page**
 number
MITSUBISHI

COLT 1200 (A 151 - G 11 B ENGINE)	4704	101
COLT 1400 (A 152 - G 12 B ENGINE)	4704	101
COLT RA4 4G12 1.4	4706	102
COLT - GALANT 72 - 78	4497	83
GALANT	4476	80
GALANT	4477	80
GALANT 1972-77	4481	80
GALANT 2000 (E 15 - 6638 ENGINE)	4704	101
LANCER 1979-81	4481	80
LANCER 1200 (A 171 - G 11 B ENGINE)	4704	101
LANCER 1400 , TIPO GALANT, POLO, COLT	4430	73
LANCER 67 - 77	4498	83
	4479	80

MORGAN

4X4 III - IV - V	3261	33
------------------	------	----

MOSKVITCH

402-407-08-412-426-2136-2137,...	3266	34
	4614	99

NISSAN

CABSTAR VH40 Z22	4726	102
NAVARA Z20, Z24	4726	102
NOMAD C22 Z24	4726	102
PATHFINDER VAGON WD21 Z24	4726	102
PATROL 60 SERIES P40	4746	103
SUNNY 1,4 (B 12, N 13) (GA 16 S ENG.)	3493	59
SUNNY 1,6 (B 12, N 13) (GA 16 S ENG.)	3493	59
URVAN E23, E24	4726	102
VANETTE C22 Z20	4726	102

OLTCIT (ROMANIA)

650 SPECIAL - CLUB 11, 11R	3241	32
650 SPECIAL - CLUB 12TRS	3241	32
AXEL 11 R - 12 R	4242	62
CLUB 11 R, 12 TR 5	4242	62

OPEL

(ENG. D 1197760)	4548	90
99 GL 2000 10/82 - 5/83	4519	86
ADMIRAL 1100 9/65 - 12/75	4507	85
ADMIRAL B	4271	62
ASCONA 1200 83	4507	85
ASCONA 13 S	4517	86
ASCONA 1300 N (MOT. 348040) 80	4508	85
ASCONA A, B, N, S	4271	62
ASCONA C 1.3 N - 1.3 S ...	4518	86
ASCONA C 1.3 N - 1.3 S ...	4533	88
ASCONA C 1300 81 ...	4507	85
BLITZ 1.9 IT. 65 - 12/75	4507	85
BLITZ, LKW	4271	62
COMMODORE	4271	62
CORSA 10 S (1000 CC - 45 HP)	4517	86
CORSA 12 S (1200 C - 55 HP)	4518	86
CORSA 12 S (1200 C - 55 HP)	4533	88
CORSA 1200 S/ST - 1300 ND/S/SB	4577	94
CORSA 1200 S/ST - 1300 ND/S/SB	4583	95
CORSA ST, N, S	3448	52
DIPLOMAT B	4271	62
KADETT 1.1/L-ASCONA KADETT-MANTA 1.2	3272	34
KADETT 12 ST (1200 CC - 55 HP)	4518	86
KADETT 12 ST (1200 CC - 55 HP)	4533	88

PUMP **PTZ** **page**
 number

KADETT 1200 S OHC	4577	94
KADETT 1200 S OHC	4583	95
KADETT 1300 (348040) 80	4508	85
KADETT 1300 81 ...	4507	85
KADETT 1300 N/NB/S	4577	94
KADETT 1300 N/NB/S	4583	95
KADETT 1600 S/SU	4577	94
KADETT 1600 S/SU	4583	95
KADETT A 1000 (40 - 48 HP) 62 - 65	3272	34
KADETT B 1100 (45 HP) - 1100 S (50 HP)	3272	34
KADETT B 1100 SR (60 HP) - 65 - 72	3272	34
KADETT B 1200 (60 HP) 61 - 62	3272	34
KADETT D 1.1 - 1.2 LITRE ...	4517	86
KADETT D 1.3 - ASCONA 1.3 - MANTA B 1.3	4507	85
KADETT D 1.3 LITRE (ENG. 13 - 348041)	4518	86
KADETT D 1.3 LITRE (ENG. 13 - 348041)	4533	88
KADETT D 1.6 - ASCONA 1.6 - MANTE	4520	86
KADETT E 1.2 S OHV	4517	86
KADETT N, S	3429	50
KADETT N, S	3448	52
KADETT S, GT	4271	62
KADETT, OLYMPIA	4271	62
KADETT, OLYMPIA 1500 9/67 - 8/70	4507	85
KADETT, OLYMPIA 1700 9/67 - 8/80	4507	85
KAPITAN	4271	62
KAPITAN 1900 9/65- 12/75	4507	85
KAPITAN 2500 (75 HP) 56 - 62	3270	34
MANTA 1300 N (MOT. 348040) 79	4507	85
MANTA B 1.6 N/ 5 - 1.9 S - 2.0 N/S	4271	62
MANTA B 18 S (1800 CC - 90 HP)	4548	90
MONZA	4271	62
MONZA	4271	62
MONZA	4271	62
MONZA 2.8 - SENATOR 2.8/3.0	4547	89
OLYMPIA - REKORD 1500 (45 HP) 56 - 62	3270	34
OLYMPIA 1100	3272	34
REKORD	4271	62
REKORD	4271	62
REKORD 1500, 1700 65 - 2/71	4507	85
REKORD AB - ADMIRAL - KAPITAN 2.6	3270	34
REKORD E 18 N (1800 CC - 75 HP)	4548	90
REKORD E 18 S (1800 CC - 90 HP)	4548	90
SENATOR	4271	62
SENATOR	4271	62
SENATOR	4271	62
VECTRA 1400 - 1600	4577	94
VECTRA 1400 - 1600	4583	95

OYAK (TURCHIA)

12 TX, 12 TSW	3312	38
9 GTL	3450	53

PAL (INDIA)

PADMINI (DERIV.DA FIAT 1000, 1100)	3024	26
------------------------------------	------	----

PAYKAN (TEHERAN)

	4703	101
1600	3289/1	35
1724	4285/1	64

PAYKAN

PAYKAN	4285	63
PAYKAN TALBOT AVENGER	3289	35

PUMP **PTZ** **page**
 number
PEUGEOT

203	3291	35
203	4291	64
204	4292	64
205	4562	92
309	3473	56
309	3485	57
404	3291	35
404	4291	64
405	3485	57
405	4562	92
504 5/34	3399	45
505	4593	97
505 5/79	3399	45
605	4562	92
104 (TUTTI I TIPI)	3293	36
106 XN	3485	57
106 XR	3485	57
106 XT	3485	57
204 1.1 J	3292	36
205 GL, GR, SR, S	3293	36
205 SPAGNA	3473	56
205 XU	4575	94
205 XU 1600	4575	94
205, 1294, RALLY	3485	57
304, 304 S	4292	64
304, 304 S 1100, 1300	3292	36
305 GL, GR, SR, S 1300, 1500	3292	36
305 GL, GR, SR, S 1300, 1500	4292	64
305 GT (MOT. XU) 1/83	4525	87
305 GT (MOT. XU) 1/83	4562	92
305 GT AUTOMAT.	4562	92
305 GT, GTX XU	4575	94
305 GTX	4562	92
305 S, GT	4562	92
306 EXPORT	3485	57
309 (TUTTI I TIPI)	3473	56
309 1600, 1900 (XU)	4575	94
309 GR, SR	4562	92
309 SVIZZERA	3472	55
309 XU 1900	4575	94
403/7 - 2/61	4295	65
403/7, 403	3291	35
403/7, 403	4291	64
403/8	3292	36
403/8	4292	64
403/U	3292	36
403/U	4292	64
405 GL, GR, SR 1600, 1900 (XU)	4575	94
504 CABRIOLET MOT V 6 10/74	4456	76
504 COUPE, CABRIOLET	4294	64
504 L, GL, GR, SR, S	3291	35
504 L, GL, GR, SR, S	4291	64
504 PU (CHINA)	4593	97
505 GL, GR, SR	3291	35
505 GL, GR, SR	4291	64
604 (USA) 10/75	4456	76
604 CABRIOLET, COUPE PF	4294	64
604 S L	4294	64

PUMP	PTZ number	page
D 3 A - D 4 A - VAN	4291	64
D3A-D4A-VAN	3291	35
GUIOT 524	3295	36
J 5	3291	35
J 5	4291	64
J 7	3291	35
J 7	4291	64
J 9	3291	35
J 9	4291	64
JEEP P 4	3291	35
JEEP P 4	4291	64
PONTIAC (USA)		
LE MANS (DAEWOO)	4271	62
RANGER		
S, SH	4271	62
RELIANT		
KITTEN	4541	89
RIALTO - FOX - ROBIN	4506	84
ROBIN	4542	89
ROBIN - BONG BUG BVG	4561	92
SCIMITAR 72	4401	68
SCIMITAR 73	4402	68
RENAULT		
4 CV, DAUPHINE, FLORIDE	3310	37
AIPINE A 110	3310	37
ALPINE A 110	3312	38
ALPINE A 110	4509	85
ALPINE A 110, 310	4314	65
ALPINE A 310	4294	64
BREAK F4	3310	37
CHAMADE RT, GTX, TXE	4586	95
CLIO RL, RN	3502	59
CLIO RL, RN	3502	59
CLIO RL, RT	3484	57
CLIO RN, TR, S	3484	57
CLIO RT	4586	95
ESPACE GTX, TX, TSE	4319	66
ESTAFETTE	3310	37
EUEGO TS, GTS A AUTOMATICA	4314	65
EXPRESS	3463	55
FUEGO	4319	66
FUEGO TX, GTX, AUTOMATICS	4586	95
FUEGO GL	3320	39
FUEGO T2, GTL	3312	38
FUEGO TX, GTX AUTOMATICS	4319	66
JEEP CJ 7	4319	66
MASTER	4319	66
NEVADA BREAK/ESTATE	4586	95
R 1 G L, TL, TA R 11 50	4509	85
R 18 (SPAGNA)	3419	48
R 18 DIESEL	4510	85
R 18 L/TL/GT L/TA/BREAK 4/78	3405	46
R 19 CHOMADE TR, TRE, GTR	3502	59
R 19 GTR	3502	59
R 19 TR	3502	59
R 19 TR, THE	3502	59
R 20 DIESEL TD, GTD	4510	85
R 5 U.S.A. 10/71	3405	46
R10, R12	3310	37

PUMP	PTZ number	page
R11	3450	53
R11	3463	55
R11 GTS, TSE	3450	53
R11 GTX - TXE 1700	4563	92
R11 TC, GTC, SOCIETE	3450	53
R11 TL, GTL AUTOMATICA	3450	53
R12 GORDINI	4314	65
R12 SENZA TURBO...	3317	39
R12L, TL, TR	3312	38
R14L, TI, TS, GTL	3293	36
R15 TL, GTL, TA	3312	38
R15 TS, TA	4314	65
R16	3310	37
R16 - R16 TA - 7/70	3313	38
R16 L, TL	3310	37
R16 L, TL, TA	3320	39
R16 TA	3310	37
R16 TS, TA, TX	4314	65
R17 TL, TS	4314	65
R18 2.0 EXPORT GTS, TX, GTX	4527	87
R18 EXPORT GTS	4586	95
R18 EXPORT GTS ,	4314	65
R18 EXPORT GTS, GTX, TX, BREAK	4319	66
R18 EXPORT TX, GTX	4586	95
R18 L, GTL, TA, BREAK	3312	38
R18 TS, GTS, TA, BREAK	3320	39
R19 GTS, RL, RN, RT, GTE	3484	57
R19 GTX - TXE - TR - THE 1700	4563	92
R19 GTX, TXE	4586	95
R19 TR TR, TRE	3450	53
R19 TS, TSE	3484	57
R19, R21 (VETT. EXTRA EUROPEE)	4586	95
R20	4319	66
R20 L, TL, GTL	4314	65
R20 LS, TS, TX, AUTOMATICS	4319	66
R21 1721 L.L. 1986...	4566	93
R21 1721 L.L. 1986...	4566	93
R21 GTS - TS - TSE - NEVADA	4563	92
R21 TL, GTL	3463	55
R25 GTS, TS, TX	4319	66
R3	3310	37
R3, R4	3310	37
R30 TS, TX	4294	64
R4	3316	39
R4 BREAK	3318	39
R4 BREAK	4318	65
R4 FURGONETTE F4	3310	37
R4 FURGONETTE F6	3318	39
R4 FURGONETTE F6	4318	65
R4 L, TL, RODEO, SAFARI	3310	37
R4 TL, RODEO, R4 F6	3318	39
R4, R4 GTL	3318	39
R4, R4 GTL	4318	65
R4, TL, RODEO, R4 F6	4318	65
R5	3310	37
R5	3315	38
R5	3316	39
R5 ALPINE	3316	39
R5 ALPINE TURBO	3428	50

PUMP	PTZ number	page
R5 AUTOMATICA	3316	39
R5 GTL	3316	39
R5 GTL	3428	50
R5 GTL AUTOMATICA	3428	50
R5 LAUREATE 1, TL, GTL	3428	50
R5 LAUREATE TURBO	3316	39
R5 LE CAR, TS, LS	3316	39
R5 SOCIETE	3310	37
R5 SOCIETE	3428	50
R5 TL	3315	38
R5 TL	3428	50
R5 TL 1300 CC II SERIE 4/7	3311	38
R5 TL, GTL	3316	39
R5 TL, GTL, LS, TS	3316	39
R5 TS, TX, AUTOMATICA	3316	39
R5 USA	3428	50
R5, VAN	3463	55
R6 TL	3318	39
R6 TL	4318	65
R6 TL - FLORIDE CARAVELLE 2/62	3455	53
R8 L	3310	37
R8, R8 GORDINI	3310	37
R8, R8 MAJOR	3310	37
R9	3450	53
R9	3463	55
R9 C, TC, GTC, TCE, L	3450	53
R9 GTS, TSE, TCE, L, AUTOMATICA	3450	53
R9 GTX - TXE 1700	4563	92
R9 TL, GTL, TLE	3450	53
RODEO 6	3428	50
RS SOCIETE	3316	39
SPRING B - BACCARA	4563	92
SUPERCINQUE GL, GTX, AUTOMATICS	3463	55
SUPERCINQUE GTR	4563	92
SUPERCINQUE TR, GTR	3502	59
TRAFFIC	3320	39
TRAFFIC	3501	59
TRAFFIC T 1000 B	4563	92
TRAFFIC T...1, P...1	3320	39
TRAFFIC T1300B, P1400B	4319	66
TRAFFIC, MICROCAR, MINIBUS	4319	66
TRAFIC	3450	53
RENAULT - FASA (SPAGNA)		
R4	3428	50
R4, R4 F6, R5 TS, R7	3316	39
R5	3428	50
R6, R12	3312	38
R7	3428	50
R9, R11	3463	55
RENAULT (ARGENTINA)		
R18 FUEGO	4319	66
R9, RL 1 (TUTTI I TIPI)	3450	53
ROVER		
214 S CARB. ENG	4595	97
METRO 1.1, 1.4 8 V CARB. ENG.	4595	97
ROVER - GROUP	3491	58
SHERPA 1.7, 2.0 (PETROL)	3572	60
SAAB		
9001985, 2000 (TIPO B) 5/78 - 1979	3394	44

PUMP **PTZ** **page**
number

900200 CC MOT. TURBO (5/81)	4552	90
99 1850 CC 1850 ...75	3396	45
99 FI 1985 10/74 - 1984	3394	44
99 GL 2000 10/82 - 5/83	4519	86
99 GL 2000 6/83	4522	87
99 MOT. TRIUMPH CC. 1700 67	3395	45

SEAT

127	3020	25
127	3333	40
133	3332	40
1500	3331	40
1281200 CC	3444	52
131 1600 CC	3443	51
131 DIPLOMATIC	3078	29
131 DIPLOMATIC	3204	31
132 (CARR)	3204	31
132 (CURB)	3078	29
600 (TUTTI I TIPI) -	3021	26
750 - 600 D/E	3334	40
850 (TUTTI I TIPI)	3056	27
EURA, IBIZA	3020	25
IBIZA (1.2 - 1.5 PORSCHE SYSTEM)	4536	88
MARBELLO	3495	59
PANDA	3410	47
PANDA	3020	25
RONDA - MALAGA (1.2 - 1.5)	4536	88
RONDA CRONO	3416	48
TOLEDO	3469	55
TRANS TE..A	3495	59

ŠKODA

1000 MB - 110 L - 110 LS - 110 R	3005	24
ESTELLE 1.0, 1.2, 1.3 OHV	4502	84
ŠKODA FAVORIT, FOREMAN, FREEWAY 1.3	4502	84

SUNBEAM

(CHRYSLER - GB) 1,0 (930)	3578	60
1,0 OHV	3576	60

SUZUKI

ALTO	4599	97
Alto (eng.SS80/F8A - SB308/F8A)	4599	97
CARRY VAN ST90V F8A	4738	103
MARUTI	4594	97
SIERRA 4x4 SJ410 F10A	4740	103
SJ 410 - SJ 410 V - SS 410 K - SS 410 W	4603	98
SJ 413, SAMURAI 1325 CC.	4597	97
SWIFT 1325 CC.	4597	97
SWIFT SF310 610A	4740	103
SWIFT SF413 (SOHC) 613B	4740	103
TULTUS 1325 CC.	4597	97

TALBOT

1510	3473	56
1610	4357	66
1100 GLS - 1100 TI - 1200 - 1200 COUPE	3351	41
1100 TI	3472	55
1100 TI (CON RICIRCOLO) 74	3356	42
1300 - 1301 - 1301 S 9/63	3352	41
1301 EXPORT - 1500 - 1501 SPECIAL/EXP...	3358	42
1301 S - 1500 - 1501 - 1501 S 9/63	3355	41
1307 (CON RICIRCOLO) 76	3356	42
1307 GLS - 1308 ...	3358	42

PUMP **PTZ** **page**
number

1307 GLS - 1308 GT/S - 1309 SX 10/75	3351	41
1307 S	3472	55
1309 SX, 1508, 1609 SX SVEZIA	3472	55
1500 LS, 1600 GLS	3473	56
1510 10/757/79	3351	41
1510 SX	3472	55
ALPINE (GB)	3473	56
ALPINE SX SOLARA	3472	55
ALPINE, PREMIUM	3473	56
ARIANE 4 - ARONDE 65	3353	41
ARIANE 7/63	3352	41
ARONDE 1200 II SERIE - 1300 ... 2/69	3353	41
ARONDE 1301 - 1501 S/LS SPECIAL .	3354	41
ARONDE 1500 - 1501 SPECIAL	3354	41
ARONDE P6 1300 CC 10/55	3352	41
BERTONE (3/15) 61 - 9/68	3350	41
CHRYSLER 160, 180, 1610, 2000	4357	66
COMMER IMP FURGONE	3384	43
COMMER PA	4285	63
COMMER PB EURGONE	4285	63
DODGE PB EURGONE	4285	63
HILLMAN AVENGER 1300, 1600	3289	35
HILLMAN ESTATE	4285	63
HILLMAN HUNTER, GT	4285	63
HILLMAN HUSKY III	4285	63
HILLMAN IMP	3384	43
HILLMAN MINX, SUPER MINX	4285	63
HORIZON GL/LS/gls/EXPORT 1/78	3351	41
HORIZON LS, GL, GLS, EX	3473	56
HORIZON PREMIUM	3473	56
HORIZON PREMIUM, SOLARA	3472	55
HORIZON SX	3472	55
HUMBER SCEPTRE	4285	63
MATRA BAGHEERA	3472	55
MATRA BAGHEERA	3473	56
MATRA BAGHEERA SX	3472	55
MATRA MURENA	3473	56
MATRA MURENA	4357	66
MATRA RANCHO	3473	56
MONTHLERY - MONACO 9/61 - 6/63	3352	41
RALLY II	3472	55
RALLY II SERIE (CON RICIRCOLO) 74	3356	42
SAMBA	3293	36
SCEPTRE H 120 C/ALTERNATORE	4285	63
SIMCA (NO RALLY)	3473	56
SIMCA 1000 - 1100 - 1100 S - 1100 GL	3351	41
SIMCA 1307 GLS, S, 1308 GTS	3473	56
SIMCA 1309 SX	3473	56
SIMCA 900 - 1000 EXPORT - COUPE	3350	41
SINGER CHAMOIS	3384	43
SINGER GAZELLE VI - VOGUE	4285	63
SOLARA (SENZA RICIRC. CARB.)	3473	56
SOLARA 1100 GL/LS/GLS/SX 4/80	3351	41
SOLARA 1500 (CON RICIRCOLO) 82	3356	42
SOLARA LS, GL, GLS, SX	3473	56
SUNBEAM 1300, 1600	3289	35
SUNBEAM ALPINE, H 120, RAPIER V	4285	63
SUNBEAM HUNTER	4285	63
SUNBEAM RAPIER	4285	63

PUMP **PTZ** **page**
number

SUNBEAM, IMP, STILETTO, SPORT	3384	43
TAGORA VS, SX	4294	64
TAGORO GL, GLS	4357	66

TOYOTA

(1200 CC - 18 R ENG.)	4480	80
(1200 CC - 3 KHS/3 KC ENG.)	4449	75
(1600/1800 CC - 12 TN - 13T/V ENG.)	4535	88
(2 K - 2 K - 4 K ENG.)	3459	54
(2 TUBETTI)	4472	79
(2200 CC - 3 A/C ENG.)	4485	78
(Z E ENG.)	3487	58
22 R (2200 CC)	4465	78
2F LANDCRUISER FJ40, 45	4722	102
2F LANDCRUISER FJ60	4722	102
3 K - PUBLICA 3 K 72 - 74	4423	71
CANNA 1,6 (TA 40, 60/2 T ENG.)	3494	59
CARINA (2 T - G ENG.)	4578	94
CARINA (TA)	4535	88
CARINA 1,6 (TA 40, 60) (2 T ENG.) OHV	3494	59
CARINA T/2T 70-72	4419	71
CARINA T-2T 72 - 74	4411	69
CARINA TA 40 (2 TC ENG.)	4458	77
CAROLLA K/2 K	4457	76
CELICA (27 - G ENG.)	4578	94
CELICA (TA)	4535	88
CELICA 16R - 18R	4414	70
CELICA 2T 70-72	4419	71
CELICA 2T 72 - 74	4411	69
CELICA 6R 72-74	4417	70
CELICA RA40 18R-C	4724	102
CELICA TA 40 (2 T - G ENG.)	4578	94
CELICA TA 74	4412	70
CHASER (TX)	4535	88
CORELLA 1,6 (TE 70) (2 T, TB ENG.)	3494	59
COROLLA (KE)	4449	75
COROLLA (TE)	4535	88
COROLLA (TE) (2 T - C ENG.)	4468	78
COROLLA (TE) (2 T - C ENG./1600 CC)	4458	77
COROLLA 1,8 (TE 70) (3 T ENG.)	3494	59
COROLLA 1,8 (TT 132) (3 T ENG.)	3494	59
COROLLA 1.6 (AE 92) 1987-93	4615	99
COROLLA 1.6 (EE 90) (2 E ENG.)	4624	100
COROLLA 12 R 78	4426	72
COROLLA 3 K 70 - 72	4421	71
COROLLA 3 K 73	4420	71
COROLLA 30 (KE) (4 K - C/1300 CC)	4448	75
COROLLA FWD (EE80 - 2 EL ENG.)	3488	58
COROLLA KE 20 - 25 - 26	4423	71
COROLLA KE 70 E (4 K ENG.)	3459	54
COROLLA KE/KP	4422	71
COROLLA T/2T 70-72	4419	71
COROLLA T-2T 72 - 74	4411	69
COROLLA TE 21/27/28 74	4406	69
COROLLA TE 47 (2 T - G ENG.)	4578	94
COROLLA TE 71 E (27 - G ENG.)	4578	94
CORONA (12 R ENG.)	3458	54
CORONA (12 R ENG.)	4488	82
CORONA (TT)	4535	88
CORONA 16R - 18R	4414	70



PUMP **TZ** **page**
number

CORONA 16R/ 18 R	4408	69
CORONA 1900 EXP.	4407	69
CORONA 2 R 65 - 72	4494	83
CORONA RT132 18RC	4724	102
CORONA TT 74	4412	70
CRESSIDA MARK II-H-LUX-HI-ACE-DYNA	4608	99
CROWN R5	4413	70
DYNA	4550	90
DYNA 5 R	4427	72
DYNA 5R 67-72	4407	69
EXPORT 70 - 71	4422	71
HI - ACE (RH)	4488	82
HI - ACE 65 - 72	4494	83
HI - ACE RH 11 (12 R ENG.)	3458	54
HI - LUX (12 R ENG.)	4488	82
HI - LUX (12 WNF.)	3458	54
HI - LUX 12 R	4426	72
HI - LUX 12 R 72 - 73	4495	83
HI - LUX 2 R 65 - 72	4494	83
HI - LUX RN 30 - 40 (12 R ENG.)	4488	82
HI ACE RH 72 - 79	4427	72
HI LUX 1.8 (YN 56 R) (2 Y ENG.)	4621	100
HI LUX 2.0 4 WD (RN 36, 46) (18 R ENG.)	4617	99
HI LUX 2.04 WD (YN 56) (3 Y ENG.)	4621	100
HI-ACE (RH)	4480	80
HI-ACE 5R 67-72	4407	69
HI-ACE 6R - 8R	4410	69
HI-ACE 6R/8R	4409	69
HI-ACE RH22, RH32, RH42 18RC	4724	102
HI-LUX 18 R 73-78	4408	69
HI-LUX 613 - R8 - RN - RN22 - RN27	4410	69
HI-LUX 6R - 8R 72-77	4409	69
HI-LUX RN41, RN46 18R	4724	102
LAND CRUISER (FJ) USA ...	4463	77
LAND CRUISER (FJ) USA ...	4464	78
LAND CRUISER 2 F 75 - 76	4489	82
LAND CRUISER F 70 - 72	4490	82
LAND CRUISER F 72 - 73	4460	77
LAND CRUISER FJ 40 - FJ 55 - 2 F ENG.)	4491	82
LAND CRUISER FJ/FH	4403	68
LANDCRUISER FJ40,45 2F	4748	104
LANDCRUISER FJ40,55 F	4748	104
LANDCRUISER FJ62,70,73,75 3F	4749	104
LIGHT - ACE (KM)	4449	75
LIGHT-ACE (YM) - TOWN-ACE (YR)	4565	92
LITE ACE 1.5 (KM 36) (5 K ENG.)	4622	100
MARK II	4535	88
MARK II 16R - 18R	4414	70
MARK II 6R - 8R/CORONA 8R	4409	69
MARK II 6R 69-72	4415	70
MARK II 6R 72-73	4416	70
MARK II 6R - 8R	4410	69
MASTER-ACE (YR) ...	4565	92
PUBLICA 3 K/LIGHT ACE KW 10	4421	71
PUBLICA KP 30/31/36/37/45/47/40	4420	71
PUBLICA(KP)	4449	75
RN 22 72	4409	69
RX 12/22/28	4410	69
STARLET (EP) (1000 - 13000 CC - IE/ALL)	3487	58

PUMP **PTZ** **page**
number

STARLET (EP)(1300 CC.-2 E/LJ/LC/ECE ENG	3488	58
STARLET 3 K 73 -	4420	71
STARLET KP 60 - 61 - 62	3459	54
STATION WAGON	4403	68
STOUT 5 R 72 - 79	4427	72
STOUT 5R 67-72	4407	69
T-18 TE72 3T-C	4747	103
TAJO - ACE (RY)	3458	54
TOJO - ACE (BY)	4488	82
TRUCK FA/FC	4403	68
	4418	71
TOYOTA (USA)		
	4433	73
	4434	73
TRABANT		
TRABANT 1100 VAG TYPE 111	4600	98
TRIUMPH		
1300	4496	83
1500	3409	47
1300/1500 SIMILAR A TOLEDO	3413	47
2000 OHV	3408	47
2000 OHV	4452	76
2500 TC OHV	4452	76
6T6 2.0 (ENG. KC 500 1 E)	3408	47
CON 2 RACCORDI FILETTA TI	3413	47
COURIER ...	4496	83
DAL MOT. GA 13654 A DAL MOT. GB 1-GB...	4496	83
DOLOMITE 1300 - 1500	3409	47
DOLOMITE 1800, 200 SPRINT OHC 73 - 80	3402	46
ENG. GB 1 - GB 2 2700	4496	83
G T 6	4440	74
GT 6 2.0	4452	76
GT6	4487	81
HERALD 12/50 - 13/60	4496	83
HERALD 1200 (ENG. GA 13654-)	4496	83
IDEM COME SOPRA ...	3420	48
IDEM COME SOPRA CON 2 TUBETTI	3426	49
SPITFIRE 1300	3409	47
SPITFIRE 1500	3409	47
SPITFIRE 73 - 78	3403	46
SPITFIRE MK - II - III - IV	4496	83
T R 5	4440	74
T R 6	4440	74
TOLEDO	3409	47
TR5 TR6 OHV	3408	47
TR7 OHC	3402	46
VITESSE	4440	74
	3412	47
	3427	49
Vauxhall		
ASTRA	3448	52
BEAGLE ESTATE 1256 CC..	3430	50
CANTON S, VICEROY	4271	62
CAVALIER	3386	43
CHEVETTE	3386	43
CHEVETTE	4602	98
CHEVETTE 1300 - 75	3430	50
EIRENZA	3382	43
FIRENZA 1.8/2.3 CC - VICTOR 1.8/2.3 CC	3385	43

PUMP **PTZ** **page**
number

FIRENZA MOT. 1002945 - VIVA HC 72 - 73	3383	43
MAGNUM 1800/2300 CC 73-76	3385	43
NOVA	3448	52
VICTOR FB/FC/VX4/90 65 - 67	3404	46
VIVA 1800/2300 CC 72-76	3385	43
VIVA HB	3382	43
VIVA HC	3382	43
VIVA HC	3386	43
VIVA HC 1256 CC 73 - 75	3430	50
VX 2300 S TD 76	3385	43
VX4/90 1800/2300 CC 72-75	3385	43
VOLKSWAGEN		
TYPE 2	4335/1	67
1500	4372	66
1200 (34 HP) 8/60-8/65	4370	66
CADDY	3373	42
CADDY	3469	55
DERBY	4376	67
DERBY (900/1100/1300 CC - 40/50/60 HP)	4514	85
DERBY C - CL - GL, 1300 MOT. 801 (55 PS)	4571	93
DERBY C, CL, GL	4376	67
DERBY C, CL, GL 111 1300 (55 PS)	4600	98
DERBY GCL - GL (1000/1100/1300 CC...)	4514	85
GOLF	3373	42
GOLF	4376	67
GOLF (1100/1300 CC - 50/60 HP)	4514	85
GOLF 100	4375	67
GOLF C - CL - GL (1100/1300 CC - 50/60 HP)	4514	85
GOLF C - CL - GL, 1300 MOT 801 (55 PS)	4571	93
GOLF C, CL, GL	3373	42
GOLF C, CL, GL	4376	67
GOLF C, CL, GL 111 1300 (55 PS)	4600	98
GOLF S, SL, GLS SYNCRO	3373	42
GOLF S, SL, GLS SYNCRO	3469	55
GOLF US (RABBIT) (1460 - 65 HP)	3482	57
JETTA	3373	42
JETTA	4376	67
JETTA (1300 CC - 60 HP)	4514	85
JETTA C - CL - GL 1300 MOT. 801 (55 PS)	4571	93
JETTA C, CL, GL	3373	42
JETTA C, CL, GL	4376	67
JETTA C, CL, GL 111 1300 (55 PS)	4600	98
JETTA GCL - GL (1100/1300 CC - 50/60 HP)	4514	85
JETTA S, SL, GLS SYNCRO	3373	42
JETTA S, SL, GLS SYNCRO	3469	55
PASSAT 1300 (ENG. 801 - 55 HP)	4514	85
PASSAT C - CL - GL, 1300 MOT 801 9/83	4571	93
PASSAT C, CL, GL	3373	42
PASSAT C, CL, GL	3469	55
PASSAT C, CL, GL	4376	67
PASSAT C, CL, GL (1300 CC - 55 HP)	4514	85
PASSAT CI 15 - GL 15 1900 CC - 100	4589	96
PASSAT SYNCRO	3373	42
PASSAT1300	4376	67
POLO	4376	67
POLO (900/1100/1300 - 40/50/60 HP)	4514	85
POLO C - CL - GL (1000/1050/1300 CC...)	4514	85
POLO C - CL - GL, 1300 MOT. 801 (55 PS)	4571	93
POLO C, CL, FOX 111 1050 (49 PS)	4600	98

PUMP
PTZ
number
page

POLO C, CL, GL	4376	67
POLO COUPE	4376	67
POLO COUPE 111 1300 (55 PS)	4600	98
POLO COUPE GT	4376	67
POLO COUPE GT MOT. 801 (PS) 9/83	4571	93
SANTANA	4376	67
SANTANA C - CL - GL, 1300 (55 PS))/83	4571	93
SANTANA C, CL, GL	3373	42
SANTANA C, CL, GL	3469	55
SCIROCCO	3373	42
SCIROCCO	3469	55
SCIROCCO	4376	67
SCIROCCO (1100/1300 CC - 50/60 HP)	4514	85
SCIROCCO 1100 - 1300 (50 - 60 PS) 8/82	4571	93
SCIROCCO TYPE 53 1300 CC.	4600	98
TYPE 1	4372	66
TYPE 1	4377	67
TYPE 1 1302 S, GHIA	4372	66
TYPE 1 1303	4377	67
TYPE 1 1303S	4377	67
TYPE 122	4372	66
TYPE 124	4372	66
TYPE 126	4372	66
TYPE 181 EURGEONE	4377	67
TYPE 181 FURGONE	4372	66
TYPE 2	4372	66
TYPE 2	4377	67
TYPE 2	4377	67
TYPE 2 Synchro	4335/1	67

VOLKSWAGEN (BRASILIE)

APOLLO, GOL, PARATI	3469	55
DASHER	3373	42
GOL	3373	42
GOL, SAVEIRO, PARATI, VOYAGE	3373	42
GOL, SAVEIRO, PARATI, VOYAGE	3469	55
PARATI, SAVEIRO, VOYAGE	3373	42
PASSAT (TUTTI I TIPI)	3373	42
SANTANA, QUANTUM	3373	42
SANTANA, QUANTUM, LOGUS	3469	55
VOYAGE, SAVEIRO	3469	55

VOLVO

164	4400	68
142.144.145	4400	68
240 2000, 2100, 2300	3462	54
240, 260	4294	64
242, 244, 245 B 21 A	3462	54
242,244,245	4400	68
243 DL/GL/245 DL/GL/345 1400 CC	3400	45
244 B/19 - 245 9/74	3401	45
264 D L, GL	4294	64
340 2000	3462	54
340 (B 172 ENG.)	4567	93
340, 343, GL, DL, L	3312	38
345 2000	3462	54
345 GL, DL	3312	38
360 2000	3462	54
360 GLE 1700 1982...	4566	93
66 408 CC	3312	38
740 2000, 2300	3462	54

PUMP
PTZ
number
page

740, 760	4294	64
DAF 55 66	3310	37
DAF MARATHON	3310	37
P 1110, 2100, 2200	4400	68
P 1800, 2100, 2200	4400	68
VOLVO 66	3310	37

ZASTAVA

127	3452	53
750	3021	26
850	3021	26
101 - 128 II SERIE 74	3479	57
101 - 128 MOT. 1116	3479	57
1300 F FURGONE - KOMBI	3070	29
KORAL 55 MOT. 1116 7/90	3479	57
SANA	3478	57
SKALA 128 - 101	3479	57
YUGO 45-A (AMERICA)	3020	25
YUGO 55 MOT. 1116	3479	57
YUGO FLORIDA	3478	57
YUGO KORAL 45	3020	25

PUMP
PTZ
number
page

PUMP	PTZ number	page
ACMAT		
APPLIC. DIVERSE	6067	122
APPLIC. DIVERSE	6081	125
ACTIV FISCHER		
COMBINE 800	6062	121
AEBI		
MEZZI AGRICOLI	6085	127
AEC		
AV 275, 312, 319, 470 E	6065	122
AV 470 E, 590	6065	122
AV 505	6065	122
AV 690/58	6065	122
INDUSTRIALE	6065	122
RELIANCE EXPRESS COACH	6065	122
AIFO		
INDUSTRIALE	6003	107
INDUSTRIALE	6006	108
ALBION		
NIMBUS 250 EN	6018	111
ALFA ROMEO		
164	6178	138
ALFA 6	6069	123
ALFA 75	6069	123
ALFA 90	6069	123
ALFETTA TURBO D	6069	123
FURGONE 30 AR 8, 32 AR 8	6039	116
FURGONE 35 AR 8, 40 AR 8	6039	116
GIULIA, F 12	6085	127
ALLIS CHALMERS		
4000 APPLIC. DIVERSE	6067	122
B 272 TRACTOR (PERKINS 3 B/152)	6019	111
COMBINES (PERKINS P 3/144)	6019	111
TR. BTL, 12 D, 14 D, 16 D, 20 D	6065	122
TR. T 1545	6067	122
ALLIS CHALMERS (USA)		
4000 APPLIC. DIVERSE	6081	125
TR. T 1545	6081	125
ALSTHOM DIESELAIR		
2/3//4/5/6 CYL. MOTORE AGROM.	6049	118
MACCHINE AGRICOLE	6062	121
TRATTORE AGROM	6051	118
ARBOS		
APPLIC. DIVERSE	6067	122
APPLIC. DIVERSE	6081	125
ARONA		
MOTORI MARINI SERIE C. 295 LL	6027	113
ATKINSON		
L 1 266 PT	6067	122
L 1 266 PT	6081	125
ATLAS COPCO		
COMPRESSORE XA 60	6092	128
AUSTIN		
A 60 CAMBRIDGE (1 - 5 L DIESEL)	6070	123
LONDON TAXI (F X 4)	6102	130
AUSTIN MORRIS		
J 4, 250 JU, PETROL	6073	123
AVELING BARFORD		
APPLIC. DIVERSE	6086	127
DUMP TRUCK RDO 17	6067	122

PUMP	PTZ number	page
DUMP TRUCK RDO 17	6081	125
DUMPER (PERKINS SA 4)	6016	110
ROAD ROLLER (PERKINS GS 4)	6016	110
ROAD ROLLER GB 5 PERKINS 3/152	6094	129
TR. AM 100 A	6067	122
TR. AM 100 A	6081	125
AXERIO		
MOTOCOMPRESSORI A 103 - A 103 B	6000	106
MOTOCOMPRESSORI A 103 C - D 32 ...	6000	106
MOTOCOMPRESSORI A 55 - A 75	6000	106
BALKANCAR		
2/4 TON 4.203 PERKINS	6143	135
IMPEZ	6120	132
BARREIROS		
MOTORE C 60 - CAMPAGNOLA DIESEL ...	6020	112
BEARDMORE		
TAXI (PERKINS 4/99)	6056	119
BEDFORD		
BLITZ 2100	6041	116
BLITZ 22100 CE FURGONE	6082	126
C TRUCK, M TRUCK	6053	119
CA VAN DIESEL (PERKINS 4/99)	6056	119
CF FURGONE	6042	116
CF FURGONE	6062	121
CF FURGONE	6085	127
CF VAN 14 - 18 - 22 CWT (PERKINS 4/108)	6057	120
P AUTOTELAIO 300 8 330	6053	119
R TRUCK	6053	119
TD TRUCK (200/220 CU IN DIESEL)	6018	111
TJ TRUCK (ENG. 45774 - 200/220 ...)	6018	111
TJ TRUCK (ENG. 45774 - 200/220 ...)	6019	111
TJ TRUCK CO SERIE 300	6053	119
TJ TRUCK CO SERIE 330	6053	119
TK TRUCK (200/220 CU IN DIESEL)	6019	111
TK TRUCK EOM, N, O, R, T, V, NRX 3	6053	119
TL	6053	119
VA AUTOTELAIO	6053	119
	6162	137
BEDFORD INDUSTRIAL ENGINES		
B 10 (220 CU IN DIESEL)	6019	111
B 7 B (200 CU IN DIESEL)	6019	111
BERLIET		
MOT 420 - 30	6110	131
BERNARD		
MOTEURS DIESEL 32	6021	112
MOTEURS DIESEL 32	6022	112
BOLINDER MUNKTEIL		
5950	6067	122
5950	6081	125
COMBINE	6062	121
MACCHINA AGRICOLA T 430	6092	128
ST 257 COMBINE (PERKINS 4/108 TA)	6057	120
TERRIER TRACTOR PERKINS 3/152 TA	6094	129
BRAUD		
505	6067	122
505	6081	125
BRISTOL		
COMPRESSORE	6085	127
LH Serie	6504	140

PUMP	PTZ number	page
TITAN 680, 690	6065	122
BRITISH - LEYLAND COMMERCIAL		
152 TRUCK - COACH - OMNIVAR	6070	123
J 004 (ALLESTIMENTI DIVERSI)	6070	123
J 2 VAN - DIESEL	6070	123
SAVA (SPAGNA)	6070	123
BROOME ET WADE		
COMPRESSORE CAI, CATS	6092	128
COMPRESSORE CR/CV 205	6067	122
COMPRESSORE CR/CV 205	6081	125
BROYT		
ESCAVATORE	6067	122
ESCAVATORE	6081	125
ESCAVATORE X 20, X 21	6086	127
BUCHER (CH)		
TR 2200 K - TR 2500 K LEYLAND 1.5	6160	136
BUNRER		
TRACTORS D 4.203 PERKINS	6143	135
CARRARO		
SUPERTIGRE 635 CON MOT. LDA 672	6001	106
SUPERTIGRE 650 CON MOT. LDA 673	6001	106
SUPERTIGRE 835 CON MOT. LDA 672	6001	106
TIGRONE 750 - ATLAS 750	6001	106
TIGRONE 850 CON MOT. LDA 672	6001	106
TIGRONE ATLAS 765	6001	106
TIGRONE TROPICAL 750/765	6001	106
TRATTORI CON MOTORE 308	6000	106
CASE		
TR. 1190, 1290, 1390, 1490, 1690	6150	135
TR. 580	6150	135
CATERPILLAR		
V 160/300	6067	122
V 160/300	6081	125
V 40 - 60 C	6120	132
CAV		
DIESEL INJECTORS 514533/2	6121	133
EQUIPMENT LEYLAND	6504	140
CAV DIESEL INJECTOR		
BEDFORD TD E TJ (ENG. 45774 ..)	6018	111
INTERNATIONAL HARVESTER BMD ...	6018	111
PERKINS P/3144 ENGINE	6019	111
CHAMBERLAIN		
CHAMPION TRACTOR (PERKINS 4/270 TA)	6016	110
CHRYSLER		
(CYL. PETR.) ENG. 126069351	6143	135
COMMER BANTAM 4.203 PERKINS	6143	135
DIESEL	6143	135
DODGE KC WALK THRU 4.203 PERKINS	6143	135
KARRIER BANTAM MKW 4.203	6143	135
KC WALK THRU	6143	135
KC WALK THRU 4.203 PERKINS	6143	135
PA 1500/2500 (PERKINS 4/108)	6056	119
PB ENGINE 108 U 13473 - 108 U 46250	6057	120
PB VAN (PERKINS 4/108) E	6057	120
PB VAN ENGINE 108 U 13472 ...	6056	119
CIAAS		
COMPACT 25 COMBINE	6062	121
CLARK		
C 500 V 40 - 600 PD	6120	132

PUMP	PTZ number	page
C 60/70/80 'B' CY 40/60	6063	121
FAT	6085	127
FORK TRACTOR	6067	122
FORK TRACTOR	6081	125
TRACTOR 45 B	6067	122
TRACTOR 45 B	6081	125
CLARK EQUIPMENT		
SERIE 60 FORK TRUCK (PERKINS 4/270)	6016	110
COJES CRANES		
MOBILE CRANE 8270	6086	127
COMMER		
1500 15 CWT VAN (PERKINS 4/99)	6056	119
2500 15 CWT VAN (PERKINS 4/99)	6056	119
COMPRESSORE CV 250	6086	127
MK V 15 - 20 - 25 - 30 CWT (DIESEL)	6034	114
PA 1500/2500 (PERKINS 4/108)	6056	119
CONSOLIDATED PNEUMATIC		
APPLIC. DIVERSE	6092	128
COMPRESSORE 250 CFM	6086	127
CONVEYANCER		
TC SERIES 8 4.203 PERKINS	6143	135
COVENTRY		
DA 7/8 FLT	6086	127
MOT. DA 2.5	6120	132
COVENTRY CLIMAX		
FLT 4.203 PERKINS	6143	135
FORK TRUCK (PERKINS 4/107)	6057	120
CUMMINS		
INDUSTRIALE	6182	139
INDUSTRIALE	6181	139
DAF		
F 1000 CT Turbo	6181	139
DALE ELECTRIC		
GENERATORE ELETTRICO	6086	127
GENERATORE ELETTRICO	6092	128
GENERATORE ELETTRICO	6119	132
GENERATORE ELETTRICO	6023	112
DAVID BROWN		
850 4 CYL. DIESEL	6024	112
850 DIESEL	6024	112
950 DIESEL	6024	112
990 DIESEL	6024	112
TR. 1 X 58, 1190, 1290	6150	135
TR. 1390, 1490, 1690	6150	135
TR. 990, 1200, 1400 SERIE 900	6150	135
DENNIS		
DART	6067	122
DART	6081	125
DEUTZ		
TORPEDO	6175	138
TORPEDO	6179	138
TORPEDO 4506	6173	138
TORPEDO B/C 700	6176	138
DINAMICA (Brasile)		
INDUSTRIALE	6183	139
DOUGLAS		
TRACTIVE UNITS NS 8/250	6067	122
TRACTIVE UNITS NS 8/250	6081	125
TUGMASTER	6067	122

PUMP	PTZ number	page
TUGMASTER	6081	125
DRONNINGBORG		
COMBINE	6062	121
COMBINE SP	6086	127
D 1600	6067	122
D 1600	6081	125
EATON		
3.4 TON.	6120	132
EATON VELBERT		
2/4 TON 4.203 PERKINS	6143	135
EICHER		
TR. 3155, 3255, 3256	6046	117
TR. 3155, 3255, 3256	6092	128
TR. 3355, 3356	6063	121
TR. 3355, 3356	6120	132
EPPLE BUXBAUM		
COMBINE	6083	126
ERON		
	6028	113
FENWICK		
APPLIC. DIVERSE	6120	132
FLT	6063	121
J 1072 FIT	6085	127
FERRARI		
MC 60 RT CON MOT. LDA 672	6001	106
MOTOCOLTIVATORI 72 CON MOT. LOMB...	6007	108
MOTOCOLTIVATORI 72 SUPER ...	6007	108
MOTOCOLTIVATORI MC 64/68 ...	6007	108
MOTOFALCIATRICE 702/703 ...	6007	108
MOTOFALCIATRICE 703/705 ...	6007	108
MT 65/30 - 35 MT 75 CON MOT. 672	6001	106
MT 65/30 - 35 MT 76 CON MOT. 673	6001	106
TRATTORE MC 60 ...	6007	108
TRATTORE MC 60 RT ...	6007	108
FIAT		
131	6039	116
132	6039	116
131 MARENGO	6039	116
241 N - 241 TM	6031	114
ARGENTA	6039	116
CAMIONCINO E FURGONE 1100 TN	6031	114
CAMPAGNOLA	6039	116
DIESEL 241 AT - 241 F M-F	6031	113
TORPEDO - CAMPAGNOLA DIESEL DAL 1968	6005	107
TRATTORI A BENZINA MOT. 88035.42.005...	6002	106
FIAT - OM CARRELLI ELEVATORI		
D 130, D 135, D 140	6003	107
D 130 CH, D 135 C, D 140 C, 150	6003	107
DI 12, DI 15, DI 20, DI 25	6003	107
DI 130	6006	108
DI 20 C, DI 25 C, DI 30 C	6003	107
DIM 20, DIM 25	6004	107
DIM 30, DIM 35	6004	107
DM 12, DM 15	6004	107
FIAT SUPERMIRAFIORI		
MOT. PERKINS 4/99 - 4/108	6091	128
FIAT-HITACHI		
AD 4, FL 4, FL 4/C, FL 4/D	6003	107
INDROVERT TLS, TLSH, 560	6003	107

PUMP	PTZ number	page
INDUSTRIALE	6006	108
INDUSTRIALE	6006	108
INDUSTRIALE	6006	108
INDUSTRIALE	6006	108
INDUSTRIALE	6006	108
INDUSTRIALE	6006	108
INDUSTRIALE	6006	108
PALA MEC. FL 4/D, FL 4/L, FL 4/C	6004	107
FORD		
(THAMES) TRUCKS ET VANS 5.7 CWT	6017	110
FURGONI TRANSIT CON EQUIPAGGIAMENTO	6036	115
INDUSTRIALE	6023	112
INDUSTRIALE; P 4250/51, P 4347/48	6119	132
INDUSTRIALE; SIMMS P 4145/78	6119	132
INDUSTRIALE; SIMMS P 4316, P 4354	6119	132
INDUSTRIALE; SIMMS P 4353 80 HP	6119	132
NEW ANGLIA - CAPRI - CORTINA - CORSAIR	6017	110
TRANSIT	6079	124
TRATTORE	6504	140
FORD COMMERCIAL		
10 - 12 - 15 CWT VAN PICK-UP TRANS...	6056	119
2/3 TON. (4 CYL. DIESEL)	6018	111
SERIE YORK DIESEL	6036	115
THAMES 10-12-15 CWT-VAN E BUS DIESEL	6056	119
THAMES TRADE (4 CYL. DIESEL)	6018	111
TRANSIT VAN (2400 FORD)	6036	115
TRANSIT VAN (FORD 2/4 DIESEL)	6025	113
TRANSIT VAN (PERKINS DIESEL)	6057	120
FORD INDUSTRIAL ENGINES		
4 CYL. C/EQ. SIMMS P 4145 - 4178 - 4193	6018	111
6 CYL. C/EQ. SIMMS P 4316	6018	111
KENT MARINE	6017	110
FORD TRACTORS		
DEXTA LIGT	6019	111
MAJOR - SUPER MAJOR (CON EXHAUSTER)	6018	111
FREIGHT ROVER		
SHERPA 2.5 DIESEL	6159	136
G.M.		
PICK UP D 10 (Brasile)	6183	139
GOLDONI		
MOTOCOLTIVATORE EXPORT ...	6007	108
MOTOCOLTIVATORE SPECIAL ...	6007	108
MOTOCOLTIVATORI A BENZINA	6007	108
MOTOCOLTIVATORI A BENZINA	6008	108
TRATTORE GM 4 - L 30	6001	106
TRATTORE UNIVERSAL 230 CON MOT 672	6001	106
HANOMAG		
MACCHINA AGRICOLA 22 C	6083	126
MACCHINA AGRICOLA 33 C	6086	127
HEATFIELD		
DUMP TRUCK H 20	6067	122
DUMP TRUCK H 20	6081	125
HESTAIR DENNIS		
AUTOCARRO DELTA 1616	6086	127
HOBART		
300/400 A	6083	126
HOYLES HYDROVANE		
COMPRESSORE 9 UD	6085	127
HUNSLET		
TRATTORE	6023	112

PUMP	PTZ number	page
TRATTORE	6119	132
HURLIMANN		
TRATTORE H 6160	6093	129
HYDROMAC		
COMPRESSORE 85 CFM	6092	128
COMPRESSORE 85 CT, CFM	6119	132
COMPRESSORE 856 T, CFM	6023	112
COMPRESSORS 90	6085	127
ESCAVATORE 580	6067	122
ESCAVATORE 580	6081	125
ESCAVATORE 890	6086	127
ESCAVATORE IDRAULICO HI 15	6086	127
HYSTER		
4/203 IND. HUNSLETT ENGINEERING	6050	118
4/203 TA FORDSON 801 TRACTOR	6050	118
FORD TRUCK H 40 F (PERKINS 4/203)	6050	118
FORD TRUCK S 30/40 C PERKINS 3/152	6094	129
FORK TRUCK H 150, H 250	6067	122
FORK TRUCK H 150, H 250	6081	125
FORK TRUCK H 20 - 25 E - H 20 - 30 D ...	6057	120
FORK TRUCK H 20 E FIT	6085	127
FORK TRUCK H 40 H	6063	121
FORK TRUCK HB 100, H 100 C, RC 150	6067	122
FORK TRUCK HB 100, H 100 C, RC 150	6081	125
FORK TRUCK HI 10/150 F	6083	126
FORK TRUCK S 30/40 C FLT	6092	128
H 150, 275, 300, 350H	6086	127
H 60, 80 C	6120	132
M 300	6067	122
M 300	6081	125
P 4/192 COMBINE HARVESTER	6050	118
IHC		
C 1600, C 1800	6067	122
C 1600, C 1800	6081	125
IMEF		
MINESCAVATORE HE145	6124	133
MINESCAVATORE HE24	6124	133
IMR MOTORI		
S46/T, TS46/T	6151	135
IMSA		
MOT. PERKINS 4/99 Y 4/108	6076	124
533	6165	137
539	6166+KO	138
540, 560	6166	137
IMT		
5100, 5106, 5130, 5136	6151	135
INGERSOLL		
COMPRESSORE 85 CFM	6092	128
COMPRESSORE DRF 250	6067	122
COMPRESSORE DRF 250	6081	125
COMPRESSORE PI 40 WP	6092	128
DR 125/140/150	6083	126
INTERNATIONAL HARVESTER		
B 275 TRACTOR - DIESEL	6072	123
B 275 TRACTOR (3 B/152)	6019	111
B 414 TRACTOR	6072	123
B 434 TRACTOR - DIESEL	6072	123
B 450 TRACTOR (PERKINS 4/270)	6016	110
B 450 WHEEL TRACTOR	6072	123

PUMP	PTZ number	page
BC 264 PETROL ENGINE	6019	111
BD 144 DIESEL ENG.	6072	123
BD 154 DIESEL ENG.	6072	123
LOAD STAR TRUCK 1600, 1700	6067	122
LOAD STAR TRUCK 1600, 1700	6081	125
LOAD STAR TRUCK 1800	6067	122
LOAD STAR TRUCK 1800	6081	125
MACCH. LAV.COTONE 1822-2022	6181	139
PALA MECCANICA H 65	6067	122
PALA MECCANICA H 65	6081	125
PALA MECCANICA JH 60, H 65	6067	122
PALA MECCANICA JH 60, H 65	6081	125
TR. 474	6083	126
TR. 585	6083	126
ITMA		
TRATTORE A 352 CON MOT. SAME 982 L	6033	114
TRATTORE A 503 CON MOT. SAME 983 L	6033	114
IVECO		
AUTOCARRO 40, 50/8, 40/35	6006	108
AUTOCARRO 40/35 AB, 4 A/B	6006	108
AUTOCARRO 50 A/B/C, 55 A/B	6006	108
AUTOCARRO 50 NC/A, 50 NC/B	6006	108
AUTOCARRO 50 NC/C	6006	108
AUTOCARRO 50/10, 55/10, SSNC	6006	108
AUTOCARRO 50/8, 55/8, 65/10	6006	108
AUTOCARRO 55 NC/A, 55 NC/B	6006	108
AUTOCARRO 55 NC/C	6006	108
AUTOCARRO 65 A/B/C, 70 A/B	6006	108
AUTOCARRO 79/10, 75/10	6006	108
AUTOCARRO BL B N 3/4	6006	108
AUTOCARRO DAILY (TUT TIPI)	6039	116
AUTOCARRO GRINTA	6039	116
AVTOCARRO 65.9	6006/3	108
INDUSTRIALE	6006/4	108
INDUSTRIALE	6003	107
INDUSTRIALE	6003	107
INDUSTRIALE	6003	107
INDUSTRIALE	6003	107
INDUSTRIALE	6003	107
INDUSTRIALE	6003	107
INDUSTRIALE	6003	107
INDUSTRIALE	6003	107
INDUSTRIALE	6003	107
INDUSTRIALE	6003	107
INDUSTRIALE	6003	107
INDUSTRIALE	6006	108
INDUSTRIALE	6039	116
VEICOLO 65.12,79.12,79.14	6006/5	108
VEICOLO A 90.14 P, A 70.14 P	6006	108
J. C. B.		
ESCAVATORE 7, 7 C, 8	6067	122
ESCAVATORE 7, 7 C, 8	6081	125
ESCAVATORE 807	6081	125
MACCHINE AGRICOLE 413	6081	125
MACCHINE AGRICOLE 418	6081	125
MACCHONE AGRICOLE 110	6083	126
TR. 112	6081	125
TR. 114 HYDROSTATIC	6081	125

PUMP	PTZ number	page
TR. 808	6081	125
TR. 808	6086	127
JOHNSTON BROS		
APPLIC. DIVERSE	6092	128
SERIE 400	6083	126
JONES CRANES		
04 MOBILE CRANE	6511	140
04 MOBILE CRANE	6083	126
JOHN DEERE (EUROPA)		
INDUSTRIALE	6074	124
INDUSTRIALE 1120,1130,1140,1630,1640	6108	131
INDUSTRIALE 1830,1840,2020,2030,2040S	6108	131
INDUSTRIALE 2120,2130,2140,3030,3040	6108	131
INDUSTRIALE 3/4/6 Cyl.	6108	131
INDUSTRIALE 3120,3130,3140,3640,4040S	6108	131
INDUSTRIALE 940,1020,1030,1040	6108	131
KARRIER		
BANTAM MK V (LIGHT DIESEL)	6034	114
KHD (DEUTZ)		
INDUSTRIALE;B/F 3,4,5, 6 I 912/913W/T	6103	130
INDUSTRIALE;F 2 L 912	6103	130
INDUSTRIALE;F 3 L 812D,F 4 L 912/912W	6103	130
INDUSTRIALE;F 3 L 913	6103	130
INDUSTRIALE;F 4 L 812D, F 4 L 912/912W	6103	130
INDUSTRIALE;F 5 L 912/912 W, 912 D	6103	130
INDUSTRIALE;F 6 L 812 D,F 6 L 812/812W	6103	130
LAMBORGHINI		
TR 1056	6093	129
TRATTORE R 654 CON MOT. SAME 984 P	6033	114
TRATTORE C 235 CON MOT. SAME 983 L	6033	114
TRATTORE C 553 CON MOT. SAME 983 L	6033	114
TRATTORE C 653 CON MOT. SAME 1053 L	6033	114
TRATTORE R 1056 CON MOT. 986/P	6045	117
TRATTORE R 235 CON MOT. SAME 982 L	6033	114
TRATTORE R 854 CON MOT. SAME 1054 P	6033	114
LANCER BOSS		
700 FLT	6086	127
APPLIC. DIVERSE	6063	121
APPLIC. DIVERSE	6081	125
APPLIC. DIVERSE	6083	126
LAND COMMERC		
	6160	136
LAND ROVER		
ROVER 2400 - SD TURBO (VM)	6089	128
90, 110 2.5 I DIESEL	6159	136
LANDINI		
TR. 8000	6511	140
4000	6010	109
4 RM	6084	127
4000, 5000 PERKINS D 3/152	6094	129
CRAWLER TRACTORS 6500	6084	127
TR. R 9500 MK II, 4 RM	6086	127
TR ME 1100, 1134, 14500	6086	127
TR. 10500, 12500, 13500	6086	127
TR. 14500, 14500 4 RM	6086	127
TR. 4500, 5500 4 RM	6046	117
TR. 6500	6048	118
TR. 86500, 86550, 87500	6083	126
TR. MF 1104, 89500	6081	125

PUMP	PTZ number	page
TR. MF 174, MF 184, MF 194 23	6083	126
TR. MF 244	6092	128
TR. TL 1 BN	6063	121
TR. TL 19 C, TL 21 C	6092	128
TR. TL 19 C, TL 21C	6046	117
TR. TL 19 N/A, 89500	6081	125
TR. TL 20 C	6083	126
TR. TL 20N/A, TL 20 DT	6083	126
TR. TL 23	6083	126
TRATTORE 4000 ...	6011	109
WHEEL TRACTORS 6400	6084	127
WHEEL TRACTORS 6500 MK II	6084	127
WHEEL TRACTORS 7500, 7500 4 RM	6084	127
WHEEL TRACTORS 8500, 8500 4 RM	6084	127
LANDROVER		
88 ET 109 SERIES II A 1/4 PETROL, FC	6144	135
88 ET 109 SERIES III 2 1/4 ET 6 CYL. L	6144	135
LANSING BAGNALL		
APPLIC. DIVERSE	6083	126
COMMODITY TRUCK FLT	6085	127
FLT	6023	112
FLT, V 100/120/140	6119	132
LAVERDA		
APPLIC. DIVERSE M 92	6083	126
COMBINE	6511	140
COMBINE SP	6086	127
MIETTREBBIATRICE	6081	125
LEYLAND - ROVER		
344	6037	115
255, 262, 270, 272	6037	115
350 FG, 360	6118	132
BOXER	6504	140
BOXER	6081	125
BOXER BX 084, 1000, 1160	6037	115
BOXER BX 1000	6037	115
BOXER BX 1000, 1160, 1200, 1300	6037	115
BOXER BX 1200, 1300, 16 TA, 16 TF	6037	115
BOXER DV/NV	6037	115
BOZER BX 18 TF, BX 19 TA, BX 19 TE	6086	127
BUFFALO	6504	140
BUS ATLANTAN 680, 690	6065	122
BUS ATLANTAN FE 30 680, 690	6081	125
BUS BX 1200, BX 1300, BX 1425	6081	125
BUS CLYDESDALE ECD 23, ECD 27	6504	140
BUS ELETLINE FE 30	6065	122
BUS LEOPARD, VICTORY	6065	122
BUS MASTIFF	6081	125
BUS NATIONAL	6504	140
BUS VIKING EVK 55	6504	140
BUS VIKING FF 1100	6037	115
BUS WORLDMASTER	6065	122
BX1425, BX20F	6504	140
CARRO OCTOPUS 30T	6504	140
CARRO LYNX 26T, 28T	6504	140
CARRO REIVER	6504	140
CHIEFTAIN	6504	140
CLYDESDALE	6504	140
EA	6118	132
FG - FGK 30, 5200, 350 FG	6118	132

PUMP	PTZ number	page
FG 35, FGK 30, 5200	6118	132
FG 350, 360, 550, 700	6037	115
FG 350, 360, 550, 700	6037	115
FG 900	6037	115
FG 900	6037	115
FGK 100	6037	115
FGK 30 - 60, FG 350 - 360	6118	132
FM 420	6037	115
GYPSY DIESEL, EA	6118	132
INDUSTRIALE	6504	140
INDUSTRIALE	6504	140
INDUSTRIALE	6504	140
SCAMMEL ROUTEMAN	6081	125
SHERPA	6122	133
SKIDDED UNITS	6037	115
TERRIER	6123	133
TERRIER 360, 420, 600	6037	115
TERRIER 650 TR., 750 TR.	6037	115
TERRIER 830, 900 WF	6037	115
TERRIER 950 TR.	6037	115
TERRIER 650, 750, 850, 950	6037	115
TR. 245	6092	128
TR. 245, 253	6046	117
TR. 384 NUFFIELD	6037	115
TR. BISON	6504	140
TR. NUFFIELD 2100, 4100	6037	115
TR. NUFFIELD 285, 485	6037	115
TR. SCAMMEL, CONTRACTOR AV 760	6065	122
WF - WFK 100 40 K - 461616...	6118	132
WF - WFK 30, 40, 60	6118	132
WF 360, 420, 600, 830, 900	6037	115
WF 360, 420, 600, 900	6118	132
WF 830, 900, 1025	6037	115
WF 830, 900, 1025, 1160	6037	115
WFK 100, 120, 140	6037	115
WFK 30 - 40; WF 360 - 420	6118	132
WFK 30 - 40; WF 360 - 420; DIESEL	6118	132
WFK, WFK 30, 40, 60, 80	6037	115
WORLDMASTER	6081	125
LIGER		
162 GL	6124	133
LINCOLN ELECTRIC		
GENERAT. ELET. 300 ET 400 AMP.	6083	126
LINDNER		
TR. TRANSPORTER 5205	6046	117
TR. TRANSPORTER 5205	6092	128
TRATTORE	6083	126
LISTER		
ABW, AC 1, AC 2, AC 2 W BOLT YJ	6134	134
AC 1, AD 1, AC 2, AD 2	6126	133
HA, HB, LD, LS	6059	120
HL 4, HL 6, HLT 6	6125	133
LPW 2, LPW 3, LPW 4 MARINE ENGINES	6135	134
SR 2 - 3 - 4 CYL. (MOTORE MARINO)	6060	120
	6096	129
	6097	129
	6098	130
	6104	131
	6105	131

PUMP	PTZ number	page
		6111 131
		6112 131
		6113 132
		6117 132
		6116 132
LOMBARDINI		
INDUSTRIALE	6124	133
INDUSTRIALE; DIESEL	6013	109
INDUSTRIALE; DIESEL (GR. 5-7-9-10-11)	6090	128
INDUSTRIALE; DIESEL 500, 520, 530	6044	117
INDUSTRIALE; DIESEL 904 A DERIVATI	6013	109
INDUSTRIALE; DIESEL GLD 260	6044	117
INDUSTRIALE; DIESEL LDA 672, LDA 673	6090	128
LDA 672 - 673 - 832 - 833	6001	106
MOTORI (fino aprile '75) LA 400/490	6008	108
MOTORI 96 E DERIVATI	6007	108
MOTORI LA 400 - LA 490 E DERIVATI	6009	109
MOTORI LDA 450 (GRUPPO 3 - 4)	6007	108
MOTORI LDA 80 E DERIVATI	6007	108
MOTORI LDA 80/B E DERIVATI	6007	108
MOTORI SENZA MOTORINO DI AWIAM.	6007	108
MOTORI SERIE 500-503-505-507-520,...	6007	108
SUPE	6012	109
INDUSTRIALE; DIESEL LDA 832, LDA 833	6090	128
LOMBARDINI - TRATTORI		
BERTOLINI 430 CON MOT. LDA 672	6001	106
BERTOLINI 432 CON MOT. LDA 672	6001	106
BERTOLINI 440/3 C CON MOT. LDA 673	6001	106
BERTOLINI 450/3 C CON MOT. LDA 673	6001	106
LOTUS CARS		
CARS: ELITE	6035	115
ELAN 1558 CC. - ELITE	6017	110
MOT. FORD 105 E-SEVEN II-SUPER SEVEN ...	6017	110
MARSHALL		
ROAD ROLLER PERKINS D 3/152	6094	129
TPJ ROAD ROLLER (PERKINS 4/203)	6016	110
TR. TM 90	6081	125
TRACKMARSHALL (PERKINS 4/270)	6016	110
MASSEY FERGUSON		
135 TRACTOR	6061	120
135 TRACTOR - ENG. 152 UA 38570 D ...	6094	129
185/188 ENG. 248 UA 71961	6084	127
CX 65 4 AD. 236 PERKINS	6143	135
DIESEL 241 AT - 241 F M- F	6034	114
ESCAVATORE 450 C	6081	125
ESCAVATORE MF 350, W 350, MF 487	6083	126
ESCAVATORE MF 5400, 620/5, 3366	6081	125
FE 35 TRACTOR (PERKINS 23 C DIESEL)...	6034	114
FE TRACTRO (PERKINS 3/TA)	6050	118
MACCHINA AGRICOLA MF 33	6511	140
MF 1080 PHASE III	6063	121
MF 11	6511	140
MF 11 SHOVEL LOADER	6083	126
MF 155, 158, 260, 560 (4/203 Eng)	6155	136
MF 165 COMBINE	6511	140
MF 165 COMBINE	6083	126
MF 186 COMBINE	6511	140
MF 487 COMBINE	6511	140
MF 50 PHASE II SKID	6511	140

PUMP **PTZ** **page**
number

MF 65 TRACTOR MK I ET II	6143	135
MODEL 130 TRACTOR (PERKINS A 4/107)	6058	120
MODEL 135 TRACTOR PERKINS A 3/152	6094	129
MODEL 165 TRACTOR AD 4.203 PERKINS	6143	135
MODEL 20 TRACTOR (DIESEL)	6034	114
MODEL 203 PERKINS A 3/152	6094	129
MODEL 205 PERKINS A 3/152	6094	129
MODEL 500 COMBINE	6081	125
MODEL 630 COMBINE (PERKINS A 4/107)	6056	119
MODEL 685 COMBINE (PERKINS 4 A/270)	6016	110
MODEL 780 COMBINE (PERKINS 4 A/270)	6016	110
MODEL 780 COMBINE (PERKINS L 4/TA)	6016	110
MODEL 788 COMBINE (PERKINS 4 A/270)	6016	110
MODEL 86 - 6 COMBINE AD 4.203 PERKINS	6143	135
MODEL TE 20 TRACTOR /PERKINS P 3/144)	6019	111
P 3 (YUGOSLAVIA)	6050	118
P 3/TA MASSEY FERGUSON FE 35 TR ...	6050	118
P 3/TA MASSEY FERGUSON STARTER ...	6050	118
P 4 ET 4.203 D PERKINS	6143	135
TR MF RX 85 33 C, 530	6086	127
TR. 122	6023	112
TR. 122	6092	128
TR. 122	6119	132
TR. 122, MF 133/135 VIGNETO	6046	117
TR. 140 MK III, 145 V	6046	117
TR. 148 MK 111, 152, 152 ET	6046	117
TR. 165, 300, HX 21	6048	118
TR. 168, MF175/175S, 175/178	6511	140
TR. D 400 C, 4 RUOTE MOTRICI	6081	125
TR. DX 35, DX 40, HX 210	6046	117
TR. DX 45, HX 211, MF 165	6048	118
TR. IND. MF 2203 - 7, 2205 - 7	6092	128
TR. INDUSTRI. MF 30/50	6511	140
TR. INDUSTRIAL MF 30/50	6083	126
TR. LC. M APRILIA MF 100 C	6092	128
TR. LC. M. APRILIO MF 100 C	6046	117
TR. MF 1114, 1134	6100	130
TR. MF 1200, 4 RUOTE MOTRICI	6081	125
TR. MF 1250, 2720, 530	6086	127
TR. MF 133, 135	6092	128
TR. MF 135	6046	117
TR. MF 135 MK III, 135 V	6046	117
TR. MF 135, 133/2135	6092	128
TR. MF 135, 135 ET	6046	117
TR. MF 135/2135	6046	117
TR. MF 140, 140 V	6046	117
TR. MF 148	6092	128
TR. MF 148, 148/148 V	6046	117
TR. MF 150, 203, 2200	6046	117
TR. MF 152 MK III, 152 V	6046	117
TR. MF 155, 158	6063	121
TR. MF 155, 158, 260, S 60	6120	132
TR. MF 158, 158 ET, 158 MK III	6048	118
TR. MF 175/175 S, 175/178	6083	126
TR. MF 178	6083	126
TR. MF 178, 185, 188	6511	140
TR. MF 185, 188, 194	6083	126
TR. MF 186 COMBINE	6083	126
TR. MF 195	6063	121

PUMP **PTZ** **page**
number

TR. MF 206, 307 COMB. HARVESTER	6083	126
TR. MF 2203 - 7, 2205 - 7	6046	117
TR. MF 235, 245, 255	6046	117
TR. MF 235, 245, 255	6092	128
TR. MF 240, 250, 254, 550	6046	117
TR. MF 260	6063	121
TR. MF 2620, 2640, 2680	6086	127
TR. MF 2620, 2680BEUVAIS	6086	127
TR. MF 265, 274, 275	6083	126
TR. MF 275, 290, 292 (Brasile)	6183	139
TR. MF 285, 290	6083	126
TR. MF 295, 298	6063	121
TR. MF 300	6511	140
TR. MF 300, 302, 304	6048	118
TR. MF 300, 33	6083	126
TR. MF 304, 365, 31 655	6048	118
TR. MF 3303, 3305	6048	118
TR. MF 400 X/D 507, 520, 525	6081	125
TR. MF 50 PHASE II SKID	6083	126
TR. MF 50, 50 B INDUSTRI. TDL	6083	126
TR. MF 500, 507, 525	6081	125
TR. MF 550	6092	128
TR. MF 560	6048	118
TR. MF 560	6063	121
TR. MF 565, 575	6083	126
TR. MF 590	6083	126
TR. MF 590 X, 5955	6063	121
TR. MF 592	6063	121
TR. MF 595	6063	121
TR. MF 598	6063	121
TR. MF 600	6083	126
TR. MF 630	6085	127
TR. MF 675, 690	6083	126
TR. MF 765	6048	118
TR. MF NARROW	6083	126
TR. MF168, 168 MK III/168 F	6083	126
	6161	137

MORGAN

65 4/4 SERIE III - IV - V 1600	6017	110
--------------------------------	------	-----

MOSKVITCH

1700 DIESEL	6085	127
-------------	------	-----

MUIRHILL

MACCHINE AGRICOLE 5000	6081	125
TR. AGR. 4 RM	6086	127

NEW HOLUIND (FIAT - GEOTECH)

TRATTORE	6003	107
TRATTORE 350, 355, 400	6003	107
TRATTORE 420, 450, 450 DT	6003	107
TRATTORE 455	6003	107
TRATTORE 455 C, 470, 480 DT	6003	107
TRATTORE 500, 500 DT, 505	6003	107
TRATTORE 505 C, 500 DT SPECIAL	6003	107
TRATTORE 540, 550, 550 DT	6003	107
TRATTORE 555, 580, 600 DT	6003	107
TRATTORE 600 DT 3, 605	6003	107
TRATTORE 605 C, 640, 640 DT	6003	107

NISSAN (DATSUN)

EBRO PATROL 2700 DIESEL	6099	130
-------------------------	------	-----

NUFFIELD
PUMP **PTZ** **page**
number

TRACTOR 3/45, 4/65	6037	115
OPEL		
ASCONA, REKORD	6082	126
ASCONA, REKORD, REKORD TURBOD.	6082	126
OMEGA	6082	126
REKORD D	6043	117
REKORD E	6082	126
SENATOR	6082	126
PERKINS		
165 TRACTOR	6143	135
3 B/152 ALLIS CHALMERS B 272 TRACTOR	6019	111
3 B/152 INTERNATIONAL HARVESTER B275...	6019	111
3/152	6061	120
4.203 MASSEY FERGUSON 65 TRACTOR	6143	135
4/108 MARINE - (PERKINS 4/107 A)	6057	120
4/203 IND. HUNSLETT ENGINEERING	6050	118
4/203 TA FORDSON 801 TRACTOR	6050	118
4/203 V	6064	121
4/203 WILLYS PICK-UP	6049	118
4/270 COCKSHUTT 560 TRACTOR	6016	110
4/270 INTERNATIONAL HERVESTER B 450 ...	6016	110
4/270 MASSEY FERGUSON 685/780/788 ...	6016	110
4/270 MASSEY FERGUSON 780/788 ...	6016	110
4/99 BEARDMORE TAXI	6056	119
4/99 BEDFORD CA VAN	6056	119
4/99 COMMER 1500/2000	6056	119
4/99 FORD 10 - 12 - 15 CWT VAN	6056	119
4/99 MORRIS OXFORD II	6019	111
4/99 TROJAN 25 CWT BUS (DAL CH 8844)	6056	119
597 SAVIEM	6047	118
A 3/152 BOLINDER MUNKTELL TERRIER ...	6094	129
A 3/152 MASSEY FERGUSON 135 TRACTOR	6094	129
A 4/107 FORD 10 - 12 - 15 CWT VAN	6056	119
A 4/107 MASSEY FERGUSON 130 TRACTOR	6058	120
A 4/107 MASSEY FERGUSON 86/6 E 630 ...	6056	119
A 4/107 MASSEY FERGUSON CKD	6058	120
A 4/99 MASSEY FERGUSON 31 - 6 E 830 ...	6056	119
A 4/99 MASSEY FERGUSON 825 TRACTOR ...	6058	120
A II VOLKSWAGEN	6099	130
D 4.203 INDUSTRIAL APPLICATIONS	6143	135
F 3 (SIMMS IN P 4609)	6019	111
GDA AVELING BARFORD ROAD ROLLER	6016	110
INDUSTRIALE	6511	140
INDUSTRIALE	6183	139
INDUSTRIALE	6023	112
INDUSTRIALE	6046	117
INDUSTRIALE	6062	121
INDUSTRIALE	6063	121
INDUSTRIALE	6065	122
INDUSTRIALE	6083	126
INDUSTRIALE	6086	127
INDUSTRIALE	6092	128
INDUSTRIALE	6099	130
INDUSTRIALE	6100	130
INDUSTRIALE	6119	132
INDUSTRIALE	6120	132
INDUSTRIALE (DIVERSI)	6081	125
INDUSTRIALE/MARINO	6065	122
INDUSTRIALS/MARINO	6085	127

PUMP	PTZ number	page
JEEP WILLIS PICK-UP	6062	121
L 4 TA MASSEY FERGUSON 780 COMBINE	6016	110
MARINO	6081	125
MK II	6143	135
P 3 HISPANIA(SIMMS IN P4588- P4442-...)	6019	111
P 3 TA TROJAN 20 CWT	6019	111
P 3 TA TROJAN 25 CWT (CH 8845)	6019	111
P 3/144 ALLIS CHALMERS COMBINE HAR ...	6019	111
P 3/144 FORDSON DEXTA TRACTORS	6019	111
P 3/144 IND. BRITISH HOIST CRANE	6019	111
P 3/144 IND. FORD DEXTA TRACTOR ...	6019	111
P 3/144 MASSEY FERGUSON TE 20 TRACTOR	6019	111
P 3/144 TA ALLIS CHALMERS B E D 272 ...	6019	111
P 3/144 TA BRISTOL TRACTOR 22	6019	111
P 4 MASSEY FERGUSON M 65 TRACTOR	6143	135
SA 4 AVELING BARFORD DUMPER	6016	110
Z 3 C - MASSEY FERGUSON FE 35 TR. ...	6034	114
	6087	128
	6161	137
	6162	137
	6163	137
PETTERS		
PH, PJ	6130	134
PEUGEOT		
404 DIESEL VERSIONE BERLINA E TAXI	6022	112
PROMOT		
MEZZI AGRICOLI	6085	127
RANSOMERS - SIMMS - JEFFERIES		
COMBINE (PERKINS 4/107 A)	6057	120
RAPID		
MEZZI AGRICOLI	6085	127
RAYTON-FISSORE		
MAGNUM 4 X 4 TURBODIESEL	6069	123
RENAULT (RG)		
SG 2	6052	119
ROSSI		
MACCHINE AGRICOLE	6511	140
MACCHINE AGRICOLE	6083	126
ROVER		
110	6075	124
110	6078	124
2200	6150	135
2000 SC, TC	6150	135
88 ET 109 II A	6075	124
88 ET 109 III	6075	124
88 ET 109 SERIE II A	6078	124
88 ET 109 SERIE III	6078	124
LAND ROVER 90/110	6122	133
RANGE ROVER	6129	134
RANGE ROVER	6178	138
RANGE ROVER 2/4 PORTE	6178	138
RANGE ROVER 90, 110	6178	138
ROVER 2400 SD TURBA	6178	138
ROVER GROUP - AUSTIN MORRIS		
MAESTRO 2.0 D	6158	136
MAESTRO 2.0 TD	6156	136
MONTEGO 2.0 TD	6158	136
RUBERY OWEN		
TC SERIE	6063	121

PUMP	PTZ number	page
S. O. S.		
INDUSTRIALE	6081	125
INDUSTRIALS/MARINO	6085	127
SAME		
INDUSTRIALE	6145	135
INDUSTRIALE	6093	129
MOTORI INDUSTRIALI TIPO 982 L - ...	6033	114
TR. ATLANTA 45	6040	116
TR. BUFALO 130	6093	129
TR. CENTAURO 55	6038	116
TR. CENTAURO 60, LEONE 70	6040	116
TR. CONDOR SINCRO 55	6093	129
TR. DRAGO 120	6093	129
TR. EXPLORER	6145	135
TR. FRUTTERO	6145	135
TR. PANTHER 90	6093	129
TR. PULEDRO	6038	116
TR. TIGER 100	6093	129
TR. TIPI DIVERSI (VECCHI MOD)	6038	116
TRAT. MINITAURO E MIN. C CON MOT. 1053L	6033	114
TRATTORE AURORA CON MOT. 983 L	6033	114
TRATTORE BUFALO 130 CON MOT. 1056 P	6045	117
TRATTORE CORSARO CON MOT. 984 L	6033	114
TRATTORE DELFINO CON MOT. 982 L	6033	114
TRATTORE DRAGO 120 CON MOT. 1056 P	6045	117
TRATTORE FALCONE E FALCON CON MOT 983	6033	114
TRATTORE PANTHER 90 CON MOT. 985 P	6045	117
TRATTORE SATURNO CON MOT. 1054 L	6033	114
TRATTORE SIRENETTA CON MOT. 982 L	6033	114
TRATTORE TIGER 100 CON MOT. 1055 P	6045	117
TRATTORI MINITAUROL DRAGO 100 - ...	6015	110
TRATTORI SINO AL 1970	6014	109
	6029	113
SANTANA		
LAND ROVER 90, 110	6075	124
SAVIEM		
AUTOCORRO 5800, 51000	6081	125
FURGONE SG 2	6052	119
SM 5, SM 6, SM 7, SM 8, S 9 597	6095	129
SM 6 - SM 7 - SM 8 - S 9/5966	6047	118
SCHILTER		
TRATTORE	6083	126
SEDDON ATKINSON		
TRUCK MK 313/4	6081	125
VEICOLO MUNICIPI. 200 EXPORT	6086	127
SERNAGIOTTO		
MOTORE RENAULT	6015	110
SHELVOKE		
INTAPAK, PT REVOPAK	6504	140
SIMMS		
FORD YORK	6025	113
SISU (VALMET)		
BT 69 CR, 539 CITY	6065	122
R 141, 142, 149, M 169	6065	122
TRUCK 8141, 8142, 8149, M 169	6081	125
SLANZI		
DVA 1000	6012	109
INDUSTRIALE	6026	113
INDUSTRIALE (SERIE 100); DVA 460, 515,...	6043	117

PUMP	PTZ number	page
INDUSTRIALE; DVA 1550 52, 1750 S, 2700	6043	117
INDUSTRIALE; DVA 3600 TB, 2350	6043	117
MOTORI DVA 460	6042	116
MOTORI DVA 700 - 920 - 1030	6030	113
SPERRY NEW HOLLAND		
S/PROPELLED BALE WAGON	6086	127
STANDARD		
12 CWT DELIVERY VAN E PIK-UP DIESEL	6034	114
LONDON TAXI - VAUGUARD DIESEL	6034	114
STORE		
	6004	107
TAIBOT		
407	6081	125
COMMANDO 100 SERIE RG	6100	130
COMMER COMMANDO	6100	130
COMMER FOMMANDO SERIE 100 RG	6083	126
COMMER KC WALK THRU	6083	126
COMMER UC TRUCK	6100	130
COMMER VA TRUCK	6100	130
COMMER VB TRUCK	6100	130
DODGE 100	6086	127
DODGE 3.5/5/6 TON	6081	125
DODGE 6/7/8/9.5/10/11/12	6081	125
DODGE BUS LIGHT/HEAVY	6081	125
DODGE C/D 500, S/D 600 'S'	6081	125
DODGE COMMANDO 100 SERIE RG	6083	126
DODGE COMMANDO 100 SERIE RG	6100	130
DODGE D - K 500	6100	130
DODGE D 405 3, 5-5-6-7 TON	6065	122
DODGE D 405 3.5, 5, 8.5 TON	6081	125
DODGE D 406, DS00	6081	125
DODGE FURGONE PB	6085	127
DODGE KC WALK THRU	6083	126
FURGONE 1500, 2500	6085	127
KARRIER VA, VB TRUCK 8/12 TON	6081	125
KARRIER VC TRUCK 8/12 TON	6081	125
SERIE G COMMODO (100)	6081	125
SERIE K (500)	6081	125
WALK THRU 50	6083	126
TAM		
75	6167	138
2001	6166	137
TAM 90 (mot.VM) 1.518.0019A	6178	138
TOMO VINKOVIĆ		
	6090	128
TOSELLI		
TRATTORE EURO 30 - RECORD CON MOT ...	6001	106
TOWMOTOR		
560 P FLT	6023	112
560 P FLT	6119	132
FLT, V 100/120/140	6083	126
TOYOTA		
LAND CRUISER BJ 73 LV	6069	123
TRACTORUL BRASOV		
TRATTORE	6003	107
TRANSICOLD		
CARRO FRIGO	6085	127
TROJAN		
20 CWT. (PERKINS P 3)	6019	111

PUMP	PTZ number	page
------	---------------	------

TRACTORUL BRASOV

TRATTORE	6003	107
----------	------	-----

TRANSICOLD

CARRO FRIGO	6085	127
-------------	------	-----

TROJAN

20 CWT. (PERKINS P 3)	6019	111
-----------------------	------	-----

25 CWT. (CH. 8845 PERKINS P 3)	6019	111
--------------------------------	------	-----

BUS 12 PASSAGERI (PERKINS 4/99)	6056	119
---------------------------------	------	-----

UNIVERZAL

	6003	107
--	------	-----

VALTRA VALMET (SISU)

FLT	6063	121
-----	------	-----

VAUXHALL

CADTON	6082	126
--------	------	-----

VENIERI

PALA MECCANICA 92 A/3	6069	123
-----------------------	------	-----

VM

104 SU/T 2, 3, 4 CIL.	6066	122
-----------------------	------	-----

104, 106, 954, 956 SU	6103	130
-----------------------	------	-----

1056, T 1056 SU, 6105	6103	130
-----------------------	------	-----

952 SU, 953 SU	6066	122
----------------	------	-----

INDUSTRIALE	6069	123
-------------	------	-----

INDUSTRIALE 954, 956 DU	6026	113
-------------------------	------	-----

INDUSTRIALE, 295 A DERIVATI	6068	123
-----------------------------	------	-----

INDUSTRIALE; 100 SL	6026	113
---------------------	------	-----

INDUSTRIALE; 102 SU, 103 SU	6066	122
-----------------------------	------	-----

INDUSTRIALE; 104, 106 SU	6026	113
--------------------------	------	-----

INDUSTRIALE; 395 A DERIVATI	6068	123
-----------------------------	------	-----

INDUSTRIALE; HR 388, HR 388 H, HR 388 HT	6178	138
--	------	-----

INDUSTRIALE; HR 392, HR 392 H, HR 392 HT	6178	138
--	------	-----

INDUSTRIALE; HR 492 LEYLAND	6178	138
-----------------------------	------	-----

MOT. HR 388/92 H-HT HR 492-HT LEYLAND	6089	128
---------------------------------------	------	-----

MOTORI SU 104 - 106 - 954 - 956 DAL '65	6012	109
---	------	-----

T 6105 SUN	6103	130
------------	------	-----

VOLKSWAGEN

FURGONE 230/313 DIESEL	6099	130
------------------------	------	-----

FURGONE LT 28 D, LT 31 D, LT 35 D	6099	130
-----------------------------------	------	-----

VOLVO

LOADERS LM621, LM641, LM4300	6504	140
------------------------------	------	-----

TRACTOR P 300, P 830	6083	126
----------------------	------	-----

TRACTOR P 827, T 500, P 838	6083	126
-----------------------------	------	-----

TRUCK F 82, G 65, F 407	6083	126
-------------------------	------	-----

TRUCK F82, F83	6511	140
----------------	------	-----

WEATHERHILL

SHOVEL LOADER	6086	127
---------------	------	-----

YALE ET TOWNE

FLT D 51 AT 40	6063	121
----------------	------	-----

YUGO

FURG., PICK-UP 412, 615	6085	127
-------------------------	------	-----

ZMAJ

Kombajn 132-133 S44(mot.PERKINS)	6180	138
----------------------------------	------	-----

PUMP	PTZ number	page
------	---------------	------

WATER PUMPS

	100	140
--	-----	-----

	101	140
--	-----	-----

	102	140
--	-----	-----

	103	140
--	-----	-----

	105	140
--	-----	-----

	106	140
--	-----	-----

	107	141
--	-----	-----

	108	141
--	-----	-----

	109	141
--	-----	-----

	123	141
--	-----	-----







	125	141
--	-----	-----



	126	141
--	-----	-----





gasoline





fuel pumps for vehicles







PTZ





PUMP	PTZ number	original number	application
	3002	101.100402100 105.000402000 105.000402001 105.120402000 105.440402000 25066445 461-1 POC 065	ALFA ROMEO 1750, 2000 1750, 2000 - A 11-A 12 Furgone - Alfa 75 (Tutti i tipi) 1600,1800, 2000 1988-1989 Alfa Spider 1600, 2000 - Alfetta 1600, 1800, 2000 1976-1979 F 11- F 12 Furgone - Giulia GT, TI - Super 1300,1600 - Giulietta 1300 1980-1983
	3003	105.1204.020.00	ALFA 2000
	3005	110.945.020	SKODA 1000 MB - 110 L - 110 LS - 110 R
	3006	51073.70000.00.00	ALFA SUD Berlina - TI -12/72
	3007	00605 0421400 25066444 461-7 510 737 531 354 542 140 5507929 7.21775.50 8631 9.06.130.11 BC-138 POC 050	ALFA ROMEO Alfa 33, 33 S 1351, 1490, 1712 1983-1990 Alfa Sud Sprint, Veloce 1.3 -1.5 Lit. 1977... Alfa Sud, TI 1200, 1300, 1500,1700 1973... Arna (Tutti i tipi) - -
	3008	116.0804.020.04 - 116.0804.02005 116.0804.020.06	ALFA ROMEO Giulietta 1300 -1600 - 1800 77- Alfeta 2000 - Alfa 90







PUMP	PTZ number	original number	application																																																																								
	3018	4235618 - 4265958	AUTOBIANCHI (Vetture) A 112 1 a serie (2 tubetti piccoli) 6/714																																																																								
	3019	25066483 4250477 4365252 4427880 4434835 4452648 461-11 60338 60339 7703714 7718702 8606 9.06.141.11 BC-118 BC-238 MS-60338-S POC 087	<table border="0"> <tr> <td>AUTOBIANCHI</td> <td>A 112 Abarth</td> <td>1050 - 70 HP</td> <td>1979-1984</td> </tr> <tr> <td></td> <td>Y 10 Touring, Turbo</td> <td>1050</td> <td>1985-1988</td> </tr> <tr> <td>FIAT</td> <td>127 (Tutti i tipi)</td> <td>1050</td> <td>-</td> </tr> <tr> <td></td> <td>Duna 60, 70</td> <td>1100,1300</td> <td>1987-1990</td> </tr> <tr> <td></td> <td>Fiorino, Pick-up</td> <td>1050</td> <td>1979-1988</td> </tr> <tr> <td></td> <td>Ritmo 60 L</td> <td>1050</td> <td>-</td> </tr> <tr> <td>FIAT (Argentina)</td> <td>Duna</td> <td>1300,1500</td> <td>-</td> </tr> <tr> <td></td> <td>Europa</td> <td>1300</td> <td>-</td> </tr> <tr> <td></td> <td>Regatta 85 Weekend</td> <td>-</td> <td>-</td> </tr> <tr> <td></td> <td>Spazio</td> <td>1100,1300</td> <td>-</td> </tr> <tr> <td></td> <td>Uno</td> <td>1050,1100,1500</td> <td>-</td> </tr> <tr> <td>FIAT (Brasile)</td> <td>147 Panorama, Pick-up</td> <td>1050</td> <td>-</td> </tr> <tr> <td></td> <td>Elba</td> <td>1300,1600</td> <td>-</td> </tr> <tr> <td></td> <td>Premio</td> <td>1300,1600</td> <td>-</td> </tr> <tr> <td></td> <td>Uno CS, R</td> <td>1300,1600</td> <td>-</td> </tr> <tr> <td></td> <td>Uno Mille</td> <td>1050</td> <td>-</td> </tr> <tr> <td>INNOCENTI</td> <td>Elba</td> <td>1300</td> <td>1987-1990</td> </tr> <tr> <td>LADA (Brasile)</td> <td>Niva, Laika</td> <td>1300</td> <td>-</td> </tr> </table>	AUTOBIANCHI	A 112 Abarth	1050 - 70 HP	1979-1984		Y 10 Touring, Turbo	1050	1985-1988	FIAT	127 (Tutti i tipi)	1050	-		Duna 60, 70	1100,1300	1987-1990		Fiorino, Pick-up	1050	1979-1988		Ritmo 60 L	1050	-	FIAT (Argentina)	Duna	1300,1500	-		Europa	1300	-		Regatta 85 Weekend	-	-		Spazio	1100,1300	-		Uno	1050,1100,1500	-	FIAT (Brasile)	147 Panorama, Pick-up	1050	-		Elba	1300,1600	-		Premio	1300,1600	-		Uno CS, R	1300,1600	-		Uno Mille	1050	-	INNOCENTI	Elba	1300	1987-1990	LADA (Brasile)	Niva, Laika	1300	-
AUTOBIANCHI	A 112 Abarth	1050 - 70 HP	1979-1984																																																																								
	Y 10 Touring, Turbo	1050	1985-1988																																																																								
FIAT	127 (Tutti i tipi)	1050	-																																																																								
	Duna 60, 70	1100,1300	1987-1990																																																																								
	Fiorino, Pick-up	1050	1979-1988																																																																								
	Ritmo 60 L	1050	-																																																																								
FIAT (Argentina)	Duna	1300,1500	-																																																																								
	Europa	1300	-																																																																								
	Regatta 85 Weekend	-	-																																																																								
	Spazio	1100,1300	-																																																																								
	Uno	1050,1100,1500	-																																																																								
FIAT (Brasile)	147 Panorama, Pick-up	1050	-																																																																								
	Elba	1300,1600	-																																																																								
	Premio	1300,1600	-																																																																								
	Uno CS, R	1300,1600	-																																																																								
	Uno Mille	1050	-																																																																								
INNOCENTI	Elba	1300	1987-1990																																																																								
LADA (Brasile)	Niva, Laika	1300	-																																																																								
	3020	25066443 3600 4216142 4235618 4242852 4262334 4262553 4265958 4304630 4320185 4320330 4325618 4335865 4342565 4342566 4362269 4400568 4426211 4434832 461-2 5983935 701181 7564841 7.21753.50 8600 9.06.214.11 AB-370 BC-107 POC 021 POC 027 POC 069	<table border="0"> <tr> <td>AUTOBIANCHI</td> <td>A 112 R77, R79, R82</td> <td>-</td> <td>1972-1984</td> </tr> <tr> <td>FIAT</td> <td>127, Fiorino</td> <td>900 -</td> <td></td> </tr> <tr> <td></td> <td>Panda 45, 4X4</td> <td>900, 965</td> <td>1979-1991</td> </tr> <tr> <td>INNOCENTI</td> <td>Koral45</td> <td>903 -</td> <td></td> </tr> <tr> <td>SEAT</td> <td>127</td> <td>900 -</td> <td></td> </tr> <tr> <td></td> <td>Furra, Ibiza</td> <td>903 -</td> <td></td> </tr> <tr> <td></td> <td>Panda</td> <td>903 -</td> <td></td> </tr> <tr> <td>YUGO</td> <td>Koral 45</td> <td>903 -</td> <td></td> </tr> <tr> <td></td> <td>Yugo 45-A (America)</td> <td>900 -</td> <td></td> </tr> </table>	AUTOBIANCHI	A 112 R77, R79, R82	-	1972-1984	FIAT	127, Fiorino	900 -			Panda 45, 4X4	900, 965	1979-1991	INNOCENTI	Koral45	903 -		SEAT	127	900 -			Furra, Ibiza	903 -			Panda	903 -		YUGO	Koral 45	903 -			Yugo 45-A (America)	900 -																																					
AUTOBIANCHI	A 112 R77, R79, R82	-	1972-1984																																																																								
FIAT	127, Fiorino	900 -																																																																									
	Panda 45, 4X4	900, 965	1979-1991																																																																								
INNOCENTI	Koral45	903 -																																																																									
SEAT	127	900 -																																																																									
	Furra, Ibiza	903 -																																																																									
	Panda	903 -																																																																									
YUGO	Koral 45	903 -																																																																									
	Yugo 45-A (America)	900 -																																																																									







PUMP	PTZ number	original number	application
	3021	341195 707782 4009730 722933 4009731 732526 4020449 736204 4020450 975174 4058734 984519 4058736 984520 4067999 985446 4080455 999900 4080457 999901 4101418 AB-337 4117981 POC 062 4117982 4195148 4117983 4323062 4117991 4126969 4139119 4139120 4167713 4170818 4308710 4371833 701182	FIAT 126 c/dinamo 600 500 (Tutti i tipi) - FIAT (Argentina) 600, 600 D - SEAT 600 (Tutu i tipi) - ZASTAVA 750 Bn e Familiare 850
	3022	4054372 4081150 4110067 4121172 4121173 4146048 4167919 9.06.001.11 POC 085	FIAT 500 Giardiniera
	3023	25066446 9.06.176.11 39557754 AB-338 4196041 BC-123 4225568 POC 056 4336342 00.039.363.08 4364431 4160041 4374853 4169041 4389400 4169058 4434789 4226658 4434834 4226821 4434840 4235510 4445630 4434837 461-4 AB-338 461-5 POC 058 5507933 POC 090	AUTOBIANCHI A 111 - Primula 65C-Coupe S - FIAT 124 1200 7/66-1/72 124 Special, Sport 1400 1968-1974 131 1300, 1600 I.L.Monoalbero ...3/1981 1100 T4, 238 E 1200, 1400 238 B, 238 B1 1200, 1400 SEAT 124 D Pamplona 1200, 1430 131 1430 131 Mirafiori 1300, 1600 TOFAS OTO (Fiat Tur.) 124 1200, 1400 131 1300, 1430 Murat sahin, Dogan, Kartal 1600 Murat Serce 1300
	3024	4058735 4111202 4112048 4143394 4145394 4167712 4434827 570698 588722 8619 988691 988692 9.06.058.11 POC 076	FIAT 1100 D/R, 1200 1100/103, 1100 ABE FIAT (Argentina) 1100, 1100 D LOMBARDINI Industriale LDA 90/2 PAL (India) Padmini 1100



PUMP	PTZ number	original number	application
	3056	25066441 3957751 4105505 4126697 4134622 4137699 4137700 4167711 4434828 461-8 5507941 8615 9.06.055.11 AB-336 BC-124 EA 020.000.04 POC 057	FIAT 850 (Tutti i tipi) Furgone, Pulmino 850 SEAT 850 (Tutti i tipi)
	3059	4195148 - 4319577 - 4323062 - 4335817-4434830	FIAT (Vetture) 128 - 128 familiare 1 a serie - 9/74
	3060	7552705 - 4236973 - 4319578 - 4335818 - 4453166 - 4391515 - 4434833 - 5985119	FIAT (Vetture) 128 2a serie - Familiare - Rally - Special - Coupe (1100/1300 cc) 128 3P - Ritmo 60/65/75 L - Uno 55 (1100 cc) - Uno 70 (1300 cc) - Regata 1300/1500 74 -
	3062	4252801 4316006 4434838	FIAT (Vetture) X1/9 (1300 cc.) X1/9 U.S.A. (1500 cc.)



PUMP	PTZ number	original number	application																		
	3063	4129795 - 4132006 - 4168027	FIAT (Vetture) 124 Bn. 1200 cc - familiare - coupe - spyder (leva corta) 6/67																		
	3064	4286414 - 4338935 - 4434843	FIAT (Vetture) 124 Bn 1200 cc - Familiare (leva lunga - con tubetto Di ricircolo) 1 /72																		
	3065	4376770 - 4395751 - 4434836 - 4266037 - 4297956 - 4362741	FIAT (Vetture) 132 Bn. - Special - GLS 1600/1800 124 Special T 1600 cc																		
	3066	4235651 - 4276312 - 4434841	FIAT (Vetture) 124 Sport - Spyder - Coupe 1600 cc																		
	3067	25066449 4311132 4333669 461-10 82285735 82306704 82313669 82357923 82378012 8614 9.06.146.11 POC 070	<table border="0"> <tr> <td>FIAT</td> <td>124 Special T USA</td> <td>1600 1974...</td> </tr> <tr> <td>LANCIA</td> <td>Beta Coupe</td> <td>1300, 1600, 1800 -</td> </tr> <tr> <td></td> <td>Beta Coupe HPE</td> <td>...385647-385581 -</td> </tr> <tr> <td></td> <td>Beta HPE</td> <td>1600,1800 -</td> </tr> <tr> <td></td> <td>Beta Trevi</td> <td>1600 ...Mot. 385581 -</td> </tr> <tr> <td></td> <td>Beta (Tutu i tipi)</td> <td>1300,1400,1600,1800 -</td> </tr> </table>	FIAT	124 Special T USA	1600 1974...	LANCIA	Beta Coupe	1300, 1600, 1800 -		Beta Coupe HPE	...385647-385581 -		Beta HPE	1600,1800 -		Beta Trevi	1600 ...Mot. 385581 -		Beta (Tutu i tipi)	1300,1400,1600,1800 -
FIAT	124 Special T USA	1600 1974...																			
LANCIA	Beta Coupe	1300, 1600, 1800 -																			
	Beta Coupe HPE	...385647-385581 -																			
	Beta HPE	1600,1800 -																			
	Beta Trevi	1600 ...Mot. 385581 -																			
	Beta (Tutu i tipi)	1300,1400,1600,1800 -																			
	3069	4171616 - 4251447 - 4434842	FIAT (Vetture) 125 Bn. 2a serie - Special (leva lunga)																		







PUMP	PTZ number	original number	application
	3070	4045975 4048510 4048511 4055600 4055920 4059510 4065585 4067110 4073564 4080389 4080390 4080391 4081391 4087352 4091765 4099844 4119389 4119952 4126886 4133166 4139122 4434844 4447943 4447944 4447945 5951864 719386 735859 7564842 8617 9.06.186.11 BC-296 POC 077 POC 111	FIAT 1300,1500,1800, 2300 -- Uno 45 (Tutti i tipi) 900 1982-1991 Uno R89 Sting 900 - FSO (FIAT Polonia) 125 Kombi 1300,1500 ...12/1975 Polonez Alize, Amplia, Prima 1500 - Polonez Mistral, Prima 1600 - Polonez Prima 1300 - YUGO Furgone F 1300 -
	3071	988971 - 989059	FIAT 1400 - 1900
	3076	7581117 - 7581119	FIAT 126 Bis c/mot. 704
	3078	25066452 4305491 4379257 4410620 4421193 4434939 4446334 461-353 5951673	FIAT 124 USA Coupe-Spyder 2000 1979... 131 Abarth Rally - - 131 Racing - - 131 Supermirafiori 1365,1600, 2000 4/1981... 131 USA Superbrava 2000 1979... 132 2000 1977-1982 Argenta 1600, 2000 (100/110) 1982-1986 Ritmo 130 TC 2000 1984-1987 LANCIA Beta 2000, Coupe 2000 Beta Trevi 1600, Mot. 385582... - Beta Trevi 2000 - HPE, Montecarlo 2000 - Prisma LX 1600 1983-1988 SEAT 131 Diplomatic 1600, 2000 - 132 (Carb) 2000 1977-1982





PUMP	PTZ number	original number	application
	3082	25066261 4308515 4380192 4381597 4392833 4394917 4434829 461-3 7547642 7571474 8607 9.06.290.11 BC-136 POC 081	FIAT 126,126 Personal(c/alternat) 650 1972-1987
	3083	4313568 7564783	FIAT 242, 242 E, 242 EEL
	3084	4379356 7564782 BC-244	FIAT Campagnola Torpedo 6132A16Z Benzin
	3085	5957869 4392304 - 4392323 - 4392303	FIAT Strada U.S.A. (Ritmo U.S.A.) carb Ritmo Super Condizionata Ritmo 75 L - GL (Sweden) Ritmo 105 TC con cond. 03/83
	3086	4333669 - 4311132	FIAT 124 Special T mod. U.S.A. (1600 cc.) 74-
	3151	4102819	FIAT FURGONI 238 A - 1100 T mot. 217



PUMP	PTZ number	original number	application
	3200*	808.000.21561.18	LANCIA (Vetture) Appia I/II/III serie
	3201*	818.000.2195044	LANCIA (Vetture) Fulvia 2C - GT - HF - Coupe 1300/1600/2000 Rally
	3202*	815.200.22268.86	LANCIA (Vetture) Flavia Bn - 4/67
	3203	25066449 9.06.146.11 4311132 POC 070 4333669 461-10 82285735 82306704 82313869 82357923 82378012	FIAT 124 Special T USA 1600 1974... LANCIA Beta Coupe 1300, 1600, 1800 - Beta Coupe HPE ...385647-385581 - Beta HPE 1600, 1800 - Beta Trevi 1600 ...Mot. 385581 - Beta (Tutu i tipi) 1300, 1400, 1600, 1800 -
	3204	82332211	LANCIA 2000 Modello 75' Beta Montecarlo Berlina 1957... Beta Coupé HPE
	3240	AC 461-59 AC-YC 6073 Guoi59A-59-59C SEV 905.33072.3307 SEV 206.31002.46 EL SEV 200.02502.70 CK Soparis A 7357 Citroen A173.0A	CITROEN 2 CV 56 - 2 CV Fourgonette AZU 63 - Dyane (Luxe a Confort) 67





PUMP	PTZ number	original number	application
	3241	25066358 3303 3307 461-63 5400346 5507913 75515547 75522440 7.21752.50 8303 95495108 95495198 9.06.168.11 A17304 A 173 AO A1730 A1730A A 1734 AM 173 OA AM 173 OC AY1730 AY 173 OA AY 173 OC AY 1730 AY 1730 A AY 1730 RP BC-125 GZ-057 DM 1730 C DS 1730 HY 173 D HY 1730 HY 1730 A PL 3308 PL 3311 POC 320	CITROEN 2 CV 4, 2 CV 6, 2 CV Special - - 2 CV Club, 2 CV Charleston - 1968... 3, 4 CV 602, 652 1968... AKB, AK400 - 8/68-4/78 AXEL Special 652CC 1984... Acadiane 602 5/1978... Ami 6, 8 602 8/1968... Axel 602 1969-1973 Axel Export 652 7/1984... Dyane 4, 6 - 8/1968... Fourgonettes, AZU,AK,AKB - 1978... LN, LNA 652 10/1976... Mehari - 9/1968.... Mehari A 4 x 4 - 1968... Visa Special Club 650 10/1978... Visa, Visa II Special 2 Cil. 10/1978... OLTEIT (Romania) 650 Special-Club 11,11 R 650 - 650 Special-Club 12TRS 650 -
	3243	25066427 3301 461-60 5447891 5463333 5463334 5506903 8300 8301	CITROEN C 35 1985 9/73-1977 D Special, D Super,D Super 5 - 9/1967-1975 DS 20 - 9/73-1975 DS 23 carburatore - 9/1973...
	3260*	7950695 - 7971263 - 461.128 - 461.184	FORD (GB) Vetture Anglia 65-67 Capri 1300/1600 10/67-7/69 Capri 1300 GT/1600 GT 69-1 /74 Cortina MKI 1200/1300/1500 65-67 Escort 1300 68-69





PUMP	PTZ number	original number	application
	3261	1 474 926 1 475 926 109E9350 B-A 25061532 25061617 2735E9350 CA 2737E9350 A 3620 3626 461-128 461-187 461-194 461-197 461-285 461-395 6 132168 6 160 896 691F9350 AB 7950695 7971241 7971263 7971280 7971463 7990448 7.20933.50 838F9350 AA 8504595 858F9350 BA 8620 93151341 9.06.270.11 BC-116 FP 0448 FPM-032 FPM-033 G 448 G 695 GFP 3261N GFP 3262N LM-041 POC 093	FORD (EUROPA) 5/7 CWT Anglia 1965-1967 6/8 CWT Escort 1968... Anglia - 1965-1970 Capri, Capri GT 1300, 1600 1967... Cortina 1200, 1300,1500, 1600 1965-1974 Cortina Lotus 1558cc Cortina MK2 - MK3 - MK4 1300, 1600 5/70-1976 Escort 950, 1100, 1300 1975-1980 Escort, Escort GT 1100,1300 1968-1975 Fiesta 950,1100, 1300 7/76-8/88 Fiesta XR2, OHV 1600 1981-1983 Marino, 105 E 4 Cil. 1961... Transit Benzina 1968-1978 Transit GB 1600 1975... LOTUS Elan 1558, Cortina - 1967-1973 Seven, Super Seven 105,109 E 1963... MORGAN 4X4 III-IV-V Ford L34 1965... Capri 1600 JB 1969-73 Escort 1100, 1300, 1600(not twin cam) 1970-82
	3262	109E-9350 705E-9350 2735 E-9350 CA 2737E- 9350 A AC461-128 AC461-197 AC7971280 AC7971241 AC7950695	FORD Anglia OHV 65 - 05/70 Capri 1300 - 1600 67 - 07/69 Capri 1300 GT - 1600 GT 69 - 01/74 Capri 1300 - 1600 Auto Cortina MK I - 1200 - 1500 65 - 66 Cortina MK I - 1300 - 1500 66 - 67 Cortina MK II - 1300 - 1600 67 - 05/70 Escort 1300 67 - 05/70 Escort 1100 - 1300 GT 69 - 05/70
	3265	2101.1106010 4102819 4163954 4384373 7.21771.50 8520 BC-236 POC 112	FIAT 1100 T 217 - FSD (FIAT Polonia) 125 P 1300,1600 1976... LADA 21043 Station Wagon 1500 - 2105 1200,1300,1500 1973-1986 2107 1300,1500,1600 1978-1984 Niva 1600







PUMP	PTZ number	original number	application
	3266	1106010 A	MOSKVITCH 402-407-408-412-426-2136-2137-2138 - 2140 74
	3270*	816012 - 8932026 816016 - APG PE 15299 - 14604	OPEL (Vettura) Rekord AB-Admiral - Kapitän 2600 62-65 Kapitän 2500 (75 HP) 56-62 Olympia - Rekord 1500 (45 HP) 56-62
	3272	816013 - ACF RA 6900 - 2.865.303	OPEL (Vettura) Kadett A 1000 (40-48 HP) 62-65 Kadett B 1100 (45 HP) - 1100 S (50 HP) Kadett B 1100 SR (60 HP) 65-72 Kadett B 1200 (60 HP) 61-62 Kadett 1100/L - Ascona Kadett - Manta 1200 Olympia 1100
	3273	APG PE 15047 816021 - 816039 - 5506942 - 461.49	OPEL (Vettura) Kadett B 1000/1100/1200 66-7/73 Kadett C 1000/1200 8/73 Ascona A 1200 S 70-7/75 Ascona B 1200 N/S - Manta B 1200 N/S 8/75 Manta A 1200 S 70-7/75 Olympia 1100 68-71
	3280*	516533 - APG PE 14575	FORD (D) Vettura Taunus 12M - 15M - 17M 1A-serie
	3281	11554 840 - 11556 578 11 527 644 APG PE 14889 - 14917 - 14765	FORD (D) Vettura Taunus 17M 4 cil. 1700 (60 HP) 59-60 Taunus 12M 17M 1200/1500/1700 60-63 Transit 4V 1200/1500 60-64







PUMP	PTZ number	original number	application
	3286*	11.519987 - APG PE 14643	FORD (D) Vettura Taunus 17M 4 cil. 1700 (60 HP) 57-68
	3287	APG PE 14575 - 14777 11.528983 - G 516.553	FORD (D) Vettura Taunus 12M 1200 (38 HP) 52-59 Taunus 12M 1500 (55 HP) 54-59 Taunus 12M (38 HP) 59-60
	3289	25061556 25061596 461-247 71241038 71241392 71802853 71804117 7990091 8121	BUKH Industriale Talbot 1973... PAYKAN Paykan Talbot Avenger ...1990 TALBOT Hillman Avenger 1300,1600 8/1973... SUNBEAM 1300,1600 8/73-1982
	3289/1	461 - 247 71802853	PAYKAN - TEHERAN 1600
	3291	1450.11 7.21747.50 1450.14 8202 1450.16 8203 1450.22 8205 1450.30 8224 1450.71 91501190 1450.76 BC-106 25061444 CZ-055 25066362 PL 3202 3224 PL 3203 461-27 PL 3205 461-32 PL 3252 5506913 PL 3255 5506918 POC 311 791000321 POC 527 791002069	CITROEN C 25 1800, 2000 (Benzina) 9/1982... PEUGEOT 203 - - 403/7, 403 - 2/1961 404 1600 3/1960... 504 L, GL, GR, SR, S 1800, 2000 10/1968... 505 GL, GR, SR 1800, 2000 5/1979... D3A-D4A-VAN - - J 5 XN1A, XN8-Benzina 11/81-8/82 J 7 Benzina 1965... J 9 Benzina 1600, 2000 1/1980... Jeep P 4 Benzina 1981-8/82





PUMP	PTZ number	original number	application
	3292	1450.17 1450.27 1450.31 1450.32 1450.53 1450.75 25061473 3201 461-56 461-81 5506912 5506971 7.21763.50 8221 91507305-80 BC-135 CZ-056 PI 3221 POC 528 POC 669	PEUGEOT 204 1.1 J 1965-1976 304, 304 S 1100,1300 10/68-1979 305 GL, GR, SR, S 1300,1500 12/1977... 403/8 - ...2/1961 403/U - 12/1960...
	3293	1450.34 1450.52 1450.55 25061451 25061461 25066484 461-43 461-88 5506935 77.00.704.262 77.01.348.117 77.01.349.400 77.01.365.509 7910011274 7910012490 7910012506 7910014057 79.10.012.490 7.21749.50 8210 8214 91507061 91507306-80 91537966-80 91539941 931537966-80 BC-103 CZ-054 PL 3210 PL 3214 POC 099	CITROEN BX 14 (Tutti i tipi) 1360,1400 ...10/1988 BX 16 (Tutti i tipi) - 1/1984... C 15 1124,1400 7/84-9/88 LN E, RE 1100 (4 cil.) 9/1982... Visa Super GT - ...10/1988 Visa (Tutti i tipi) 1100,1400 10/1978... PEUGEOT 104 (Tutti i tipi) - 10/1972... 205 GL, GR, SR, S - 3/83-1988 RENAULT R14 L, TL, TS, GTL R1210, R1211, R1212 6/76-1983 TALBOT Samba - 11 /1981...
	3295	Guiot 524	PEUGEOT (Vetture) 403/7 - 2/61







PUMP	PTZ number	original number	application
	3311	77.00.566.659 - ACF YM 7917	RENAULT R5 TL 1300 cc II serie 4/75...
	3312	25061447 25066361 3267347-7 3277579 3277597 3277597-5 461-37 5506924 60.00.557.831 77.00.653.611 77.00.509.109 77.00.531.547 77.00.551.669 77.00.614.533 77.00.633.708 77.00.681.700 77.01.348.612 7.21740.50 7.21742.50 8017 8034 BC-112 LI-006 MS-60496-S PL 3017 PL 3034 POC 544	DACIA (Romania) 1210, 1310, 1320 1410 OYAK (Turchia) 12 TX, 12 TSW - - RENAULT Alpine A 110 R12 6/1970... Fuego T2, GTL R1360 3/1980... R12L, TL, TR - 9/1969... R15 T2, GTL, TA R1300 10/1971... R18 L, TL, GTL, TA, Break 1400 4/1978... RENAULT-FASA (Spagna) R6, R12 - 1981... VOLVO 340, 343 GL, DL, L B 14 1978... 345 GL, DL B 14 1978... 66 408CC -
	3313	8.557.928 - ACF YM 7911	RENAULT R16 - R 16 TA - 7/70
	3315	461-64 5507916 77.00.534.253 BC-130 PL 1018	RENAULT R5 - 1975 R5 TL - 10/71-2/72







PUMP	PTZ number	original number	application																																																
	3316	25061436 25066430 461-68 461-82 5506909 5507921 77.01.039.609 77.00.555.728 77.00.565.728 77.00.572.176 77.00.641.236 77.00.666.045 77.00.666.236 77.00.725.183 7.21744.50 8044 8724 9.06.288.11 BC-111 LI-005/0 PL 3044 POC 305	<table border="0"> <tr> <td>RENAULT</td> <td>R4 112C/201 C 956 <</td> <td>1986-1990</td> <td></td> </tr> <tr> <td></td> <td>R5 950</td> <td>...1984</td> <td></td> </tr> <tr> <td></td> <td>R5 Alpine</td> <td>R1223</td> <td>3/1976...</td> </tr> <tr> <td></td> <td>R5 Automatico</td> <td>R1225, 81395, 81399</td> <td></td> </tr> <tr> <td></td> <td>R5 GTL</td> <td>R1226, 81396</td> <td>5/1979...</td> </tr> <tr> <td></td> <td>R5 Laureate Turbo</td> <td>-</td> <td>7/1984...</td> </tr> <tr> <td></td> <td>R5 Le Car, TS, LS</td> <td>R1224</td> <td>3/1976...</td> </tr> <tr> <td></td> <td>R5 Societe</td> <td>R2386, 82387</td> <td>5/1979...</td> </tr> <tr> <td></td> <td>R5 TL, GTL</td> <td>R1226, 81227, 81394, 81397</td> <td>5/1979...</td> </tr> <tr> <td></td> <td>R5 TL, GTL, LS, TS</td> <td>R1224</td> <td>-</td> </tr> <tr> <td></td> <td>R5 TS, TX, Automatics</td> <td>R1229</td> <td>-</td> </tr> <tr> <td>RENAULT-FASA (Spagna)</td> <td>R4, R4 F6, R5 TS, R7</td> <td>-</td> <td>6/81-4/87</td> </tr> </table>	RENAULT	R4 112C/201 C 956 <	1986-1990			R5 950	...1984			R5 Alpine	R1223	3/1976...		R5 Automatico	R1225, 81395, 81399			R5 GTL	R1226, 81396	5/1979...		R5 Laureate Turbo	-	7/1984...		R5 Le Car, TS, LS	R1224	3/1976...		R5 Societe	R2386, 82387	5/1979...		R5 TL, GTL	R1226, 81227, 81394, 81397	5/1979...		R5 TL, GTL, LS, TS	R1224	-		R5 TS, TX, Automatics	R1229	-	RENAULT-FASA (Spagna)	R4, R4 F6, R5 TS, R7	-	6/81-4/87
RENAULT	R4 112C/201 C 956 <	1986-1990																																																	
	R5 950	...1984																																																	
	R5 Alpine	R1223	3/1976...																																																
	R5 Automatico	R1225, 81395, 81399																																																	
	R5 GTL	R1226, 81396	5/1979...																																																
	R5 Laureate Turbo	-	7/1984...																																																
	R5 Le Car, TS, LS	R1224	3/1976...																																																
	R5 Societe	R2386, 82387	5/1979...																																																
	R5 TL, GTL	R1226, 81227, 81394, 81397	5/1979...																																																
	R5 TL, GTL, LS, TS	R1224	-																																																
	R5 TS, TX, Automatics	R1229	-																																																
RENAULT-FASA (Spagna)	R4, R4 F6, R5 TS, R7	-	6/81-4/87																																																
	3317	Guiot 555 A	<table border="0"> <tr> <td>RENAULT</td> <td>R12 senza tubo di ricircolo fino al mot. 108440</td> <td></td> <td></td> </tr> </table>	RENAULT	R12 senza tubo di ricircolo fino al mot. 108440																																														
RENAULT	R12 senza tubo di ricircolo fino al mot. 108440																																																		
	3318	25061449 25066413 461-40 5506931 77.00.520.928 77.00.544.500 77.00.634.554 77.01.348.614 8014 LI-003 PL 3014	<table border="0"> <tr> <td>RENAULT</td> <td>R4 Break</td> <td>R2370, R2330, R2430</td> <td>4/1975...</td> </tr> <tr> <td></td> <td>R4 Furgonette F6</td> <td>-</td> <td>1961-1981</td> </tr> <tr> <td></td> <td>R4 TL, Rodeo, R4 F6</td> <td>-</td> <td>4/1975...</td> </tr> <tr> <td></td> <td>R4, R4 GTL</td> <td>R1128</td> <td>1/1978...</td> </tr> <tr> <td></td> <td>R6 TL</td> <td>R1181</td> <td>10/70-1980</td> </tr> </table>	RENAULT	R4 Break	R2370, R2330, R2430	4/1975...		R4 Furgonette F6	-	1961-1981		R4 TL, Rodeo, R4 F6	-	4/1975...		R4, R4 GTL	R1128	1/1978...		R6 TL	R1181	10/70-1980																												
RENAULT	R4 Break	R2370, R2330, R2430	4/1975...																																																
	R4 Furgonette F6	-	1961-1981																																																
	R4 TL, Rodeo, R4 F6	-	4/1975...																																																
	R4, R4 GTL	R1128	1/1978...																																																
	R6 TL	R1181	10/70-1980																																																
	3320	25061474 25066411 3019 461-82 5506972 77 00 551 384 77 00 632 708 77 00 663 580 77.00.436.253 77.00.532.985 77.00.532.987 77.00.556.887 77.00.636.253 77.00.696.382 77.01.348.613 77.01.349.244 7.21755.50 8033 8719 9.06.349.11 BC-108 11-040 PL 3719 POC 641	<table border="0"> <tr> <td>RENAULT</td> <td>Fuego GL</td> <td>R1361 - Mot.A2M</td> <td>1984-1985</td> </tr> <tr> <td></td> <td>R 16 L, TL, TA</td> <td>R1150, 1152, 1153, 1155, 1157</td> <td>6/72-1980</td> </tr> <tr> <td></td> <td>R 18 TS, GTS, TA, Break</td> <td>R1341, R1351</td> <td>4/1978...</td> </tr> <tr> <td></td> <td>Traffic</td> <td>1650</td> <td>1984-1993</td> </tr> <tr> <td></td> <td>Traffic T...1,P...1</td> <td>1647-Mot.841-05,A1M</td> <td>1980...</td> </tr> </table>	RENAULT	Fuego GL	R1361 - Mot.A2M	1984-1985		R 16 L, TL, TA	R1150, 1152, 1153, 1155, 1157	6/72-1980		R 18 TS, GTS, TA, Break	R1341, R1351	4/1978...		Traffic	1650	1984-1993		Traffic T...1,P...1	1647-Mot.841-05,A1M	1980...																												
RENAULT	Fuego GL	R1361 - Mot.A2M	1984-1985																																																
	R 16 L, TL, TA	R1150, 1152, 1153, 1155, 1157	6/72-1980																																																
	R 18 TS, GTS, TA, Break	R1341, R1351	4/1978...																																																
	Traffic	1650	1984-1993																																																
	Traffic T...1,P...1	1647-Mot.841-05,A1M	1980...																																																







PUMP	PTZ number	original number	application
	3331	CA 02.0000.06	SEAT 1500
	3332	DB 02.0000.01 - 4340115	SEAT 133
	3333	HB 02.0000.05 - 4262334	SEAT 127
	3334	BD 02.0000.02	SEAT 750 - 600 D/E
	3335	647.702500	CITROEN 3 CV a C8 (Spagna)
	3340	4384373	POLSKI (Fiat Polonia) 125 P - 1300/1500 Polonez 76







PUMP	PTZ number	original number	application
	3350	22117D - 24189 Q - Guiot 541	TALBOT Simca 900 - 1000 Export - Coupe Bertone (3/15) 61-9/68
	3351	29988 W - 558265.00 - Guiot 543/A	TALBOT Simca 1000 - 1100 - 1100 S - 1100 GL 10/68 1100 GLS - 1100 TI - 1200 - 1200 Coupe 9/67 1307 GLS - 1308 GT/S - 1309 SX 10/75 Horizon GL/LS/GLS/Export 1/78 Solara 1100 GL/LS/GLS/SX 4/80 1510 10/75/79
	3352	16881 G - Guiot 540	TALBOT Aronde P6 1300 cc 10/55 Ariane 7/63 Monthlery - Monaco 9/61-6/63 1300 - 1301 - 1301 S 9/63
	3353	5506917 - Guiot 540 C - Soparis 7155	TALBOT Aronde 1200 II serie - 1300 ~ 2/69 Ariane 4 - Aronde 65
	3354	26789 T - Guiot 542 U	TALBOT Aronde 1301 - 1501 S/LS Special 12/68-75 Aronde 1500 - 1501 Special
	3355	29186 H	TALBOT 1301 S - 1500 - 1501 - 1501 S 9/63







PUMP	PTZ number	original number	application
	3356	43106 Y - 131 885.00	TALBOT 1100 Ti (con ricircolo) 74 1307 (con ricircolo) 76 Rally II serie (con ricircolo) 74 Solara 1500 (con ricircolo) 82
	3358	38540 H - Guiot 542	TALBOT 1301 Export - 1500 - 1501 - 1501 Special/Export 1307 GLS - 1308 Special GT con ricircolo 12/69
	3373	021 127 025 056121 0251 056 127 025 056127 025 2 056127 025 3 056127 025 4 056 127 025 A 056127 025 B 056127 025 C 25066360 3500 461-77 60442 60446 7.10061.50 7.20035.00 7.20061.50 7.20068.50 7.20400.50 7.20663.50 7.20802.50 7.20802.51 7.20802.52 7.20803.50 7.20803.53 8500 9.06.302.11 BC-153 POC 501	AUDI 100 Avant 1800 (75 PS) 9/82-12/84 100 C, CL, CS, GL 1600 8/81-8/86 80 1600 (100 PS) 10/73-7/75 80 827 1,3/1,5/1,6(55/85 PS) 8/72-9/81 80 Coupe GLS 1800 (90 PS) 8/82-10/84 80 C, CL, GL Coupe 1300, 1600 (60/85 PS) 10/81-1/85 80, 100 1500, 1600 12/72-3/79 Coupe 1800 (75/90 PS) 10/80-8/84 FORD (Brasile) Belima, Del Rey, Pampa 1800 ...1/1991 Escort Ghia, XR-3, Verona 1800 1/1991 FOX - Audi 8/1973... VOLKSWAGEN Caddy Veicolo industr.1500,1600 1982... Golf 1500, 1600 (70/75 PS) 4/74-9/81 Golf C, CL, GL -1500, 1600 (70/85 PS) 10/81-6/83 Golf S, SL, GLS Syncro 1600, 1800 (72/90 PS) 7/1983... Jetta 1500 (70 PS) 9/79-9/81 Jetta C, CL, GL 1500, 1600 (70/85 PS) 10/81-8/83 Jetta S, SL, GLS Syncro 1600, 1800 (72/90 PS) 7/83-11/84 Passat C, CL, GL 1600 (75/85 PS) 1 0/80-9/84 Passat Syncro 1800 (87/90 PS) 8/82-10/84 Santana C, CL, GL 1600,1800 (75/90 PS) 9/83-10/84 Scirocco 1500,1600,1800 (70/90 PS) 4/74-10/84 VOLKSWAGEN (Brasile) Dasher 1500, 1600, 1800 1974-1976 Gol 1600 (Raffr. ad acqua) 10/1989 Gol, Saveiro, Parati, Voyage 1800 01/1991 Parati, Saveiro, Voyage 1600 10/1989 Passat (Tutti i tipi) 1500,1600, 1800 - Santana, Quantum 1800, 2000 ..1/1991 Passat, Golf 1974-80
	3380	AUF 715	BRITISH LEYLAND Morris 1300 - Minor 850 - 1100 BE - 1275 - 1300 Travel Allegro 1100/1300





PUMP	PTZ number	original number	application
	3381	53261001 53261002 9.06.811.11 AUF 816 POC 504	INNOCENTI Mini 1001 - 1971-1974 Mini, Mini 90, Mini 1275 GT - 1969-1982
	3382	25061509 25066414 461-129 7950728 POC 671	BEDFORD Beagle Estate Car 1159,1256 1965... HA Furgane b/8 cwt. - 1965... VAUXHALL Firenza - 1970-1972 Viva HB - 1966-1970 Viva HC - 1970-1972
	3383*	7990053	VAUXHALL Firenza mot. 1002945 - Viva HC 72-73
	3384	25061534 25066415 461-206 7101101 7101101B 7971329	TALBOT Commer Imp Furgone - 1965-1976 Hillman Imp - 1965-1976 Singer Chamois - 1965-1973 Sunbeam, Imp, Stiletto, Sport - 1965-1976
	3385*	7990041-461.237	VAUXHALL Firenza 1800/2300 cc - Victor 1800/2300 cc VX4/90 1800/2300 cc 72-75 Magnum 1800/2300 cc 73-76 Viva 1800/2300 cc 72-76 VX 2300 Std 76
	3386	25061579 461-277 7971483 7990375 POC 676	BEDFORD Chevanne - 1976... VAUXHALL Cavalier 1300 8/76-1979 Chevette 1300 1975... Viva HC 1256 1974...







PUMP	PTZ number	original number	application
	3387	AUF 711	BRITISH LEYLAND Morris Marina 1800 - TC - Automatic Sherpa 185 - 215 - 220 - CV 215 - 240 - 306 Morris 185 - 215 - 220 - Van - 215 - 220 - 240 - 25 LC Aurto Van 71-78
	3389	AUF 704-803	BRITISH LEYLAND Princess 1800 - Automatic - MKII - 1800 MKII Automatic 1800 S 68-75
	3391	AUF 810	BRITISH LEYLAND Princess 2200 75
	3392	AUF 818	BRITISH LEYLAND Princess 2200 Automatic 75
	3393	4382283 - 4434836 4413008 - 4395751 4376770 - 4362741 4297956 - 4266037	FIAT 132 Bn - 132 Special (1600 cc.) 132 Bn - 132 Special (1800 cc.) 132 GLS (1600-1800 cc.) 03/81 124 Special T (1600 cc.) 124 Sport (1800 cc.) 124 U.S.A. Coups & Spider (1800 cc.) 131 TC Supermirafiori (1300-1600 cc.) 03/81 131 Brava U.S.A. (1800 cc.) 77-78
	3394	25061609 461-239 461-275 7990358 834617 8348617 8414 8817603 9314055 93151086 9.06.816.11 BC-213 POC 649	SAAB 900 1985, 2000 (Tipo B) 5/78-1979 99 FI 1985 10/74-1984





PUMP	PTZ number	original number	application
	3395	8303844 - 7971245	SAAB 99 mot. Triumph cc 1700 67
	3396	8311821 - 7990358	SAAB 99 1850 cc ~ 75
	3397	25066258 4434851 4441918 4441919 4441920 461-378 7564781 8616 9.06.183.11 BC-199 POC 095	FIAT Panda 30 (Tutti i tipi) 650
	3399	1450.22-791 000 319	PEUGEOT 504 10/68 505 5/79
	3400	3277.597.5 - 3267.347.7 - Guiot 591	VOLVO 243 DL/GL/245 DL/GL/ 343 DL/GL/ 345 1400 cc
	3401	463.348 - 1.219.7331.1	VOLVO 244 B/19 - 245 9/74







PUMP	PTZ number	original number	application	
	3402	312167	TRIUMPH	Dolomite 1800, 2000 Sprint OHC Tr7 OHC 1973 - 80 1976 - 82
	3403	RKC 1624 - OEM K 1067 69	TRIUMPH	SPITFIRE 79-78
	3404*	7950586	VAUXHALL	Victor FB/FC/VX4/90 65-67
	3405	77 00 614 533 - 5506944 - RA 6944	RENAULT	R5 U.S.A. 10/71 R18 L/TL/GTL/TA/Break 4/78
	3406	TKC 3418	M.G. (Vetture)	Midget 78
	3407	4395751-4434836	FIAT (Vetture)	132 L





PUMP	PTZ number	original number	application
	3408	213577	TRIUMPH 616 2.0 (eng. KC500 1 C) Tr5 Tr6 OHV 2000 OHV 1968 - 74 1967 - 75 1968 - 69
	3409	AC 7990445 RMC 001624.000 AC 461-218 7971401	TRIUMPH Dolomite 1300-1500 Spitfire 1300 Spitfire 1500 Toledo 1500 76 - 80 67 - 74 74 - 75 70 - 76 70 - 73
	3410	HB 02.0000.06	SEAT Panda
	3412	TKC 3417	TRIUMPH
	3413*	EO 661	TRIUMPH 1300/1500 similar a Toledo Con 2 raccordi filettati
	3414	4429604	FIAT 131 Moncalbero





PUMP	PTZ number	original number	application
	3415	4428293	FIAT 132/2000
	3416	00.039.362.74 25066268 3936274 3957756 4435013 4463373 461-388 5936384 5936385 7564245 82353533 8608 9.06.192.11 AB-598 BC-115 POC 604	FIAT Regata 100 v.7056786-7380450 1600 TC ...1984 Ritmo 100 S ...vett.4880206 1600 Ritmo 105 TC 1600 - LANCIA Beta USA, Svezia 2000 - Delta GT 1600 TC 1983-1986 Prisms 1600 ...1984 SEAT Ronda Crono 1600 -
	3417	82353533	LANCIA Beta 2000 (U.S.A. - Svezia)
	3419	77 01 348 117	RENAULT R18 (Spagna)
	3420	7950661 - 7950191 - 203254	TRIUMPH Idem come sopra senza leva adescamento





PUMP	PTZ number	original number	application
	3422	AUF 805	BRITISH LEYLAND Austin Mini ECE
	3423	AUF 809	BRITISH LEYLAND Austin Allegro 1500/1750 - HL - Sport 73
	3424	XP 51052 - 93151052	BRITISH LEYLAND Austin Allegro 1100/1300 - Austin 7cwt Van 1100 Austin 10 cwt Van ECE 1300
	3425	93151054 - XP 51054	BRITISH LEYLAND Mini Clubman 1000 - 1275 GT 69-71 Mini MKII 850/1000/1100/1300 69 Mini MKII 1100/1300 71-76 Mini 1100 75
	3426	EO 661	TRIUMPH Idem come sopra con 2 tubetti
	3427	TKC 3419 - 7990045	TRIUMPH





PUMP	PTZ number	original number	application																																		
	3428	25061435 25066429 461-65 461-91 5506908 5507917 77.00.730.665 77.00.566.859 77.00.641.235 77.00.646.046 77.00.666.046 77.02.144.230 7.21745.50 8046 9.06.110.11 BC-119 BC-170 LI-005 PL 3046 POC 302	<table border="0"> <tr> <td rowspan="10">RENAULT</td> <td>R5 ALPINE TURBO</td> <td>1228 - Mot.840</td> <td>1983-1985</td> </tr> <tr> <td>R5 GTL</td> <td>R1395</td> <td>3/76-5/79</td> </tr> <tr> <td>R5 GTL Automatica</td> <td>R1225</td> <td>5/1978...</td> </tr> <tr> <td>R5 Laureate 1, TL, GTL -</td> <td></td> <td>7/1984...</td> </tr> <tr> <td>R5 Societe</td> <td>R2382</td> <td>10/75-1979</td> </tr> <tr> <td>R5 TL</td> <td>R1222</td> <td>4/1973...</td> </tr> <tr> <td>R5 USA</td> <td>R1228</td> <td>6/1975...</td> </tr> <tr> <td>Rodeo 6</td> <td>ACLIA</td> <td>1973...</td> </tr> <tr> <td>RENAULT-FASA (Spagna) R4</td> <td>-</td> <td>4/1987...</td> </tr> <tr> <td>R5</td> <td>-</td> <td>1975-1985</td> </tr> <tr> <td>R7</td> <td>-</td> <td>-</td> </tr> </table>	RENAULT	R5 ALPINE TURBO	1228 - Mot.840	1983-1985	R5 GTL	R1395	3/76-5/79	R5 GTL Automatica	R1225	5/1978...	R5 Laureate 1, TL, GTL -		7/1984...	R5 Societe	R2382	10/75-1979	R5 TL	R1222	4/1973...	R5 USA	R1228	6/1975...	Rodeo 6	ACLIA	1973...	RENAULT-FASA (Spagna) R4	-	4/1987...	R5	-	1975-1985	R7	-	-
RENAULT	R5 ALPINE TURBO	1228 - Mot.840	1983-1985																																		
	R5 GTL	R1395	3/76-5/79																																		
	R5 GTL Automatica	R1225	5/1978...																																		
	R5 Laureate 1, TL, GTL -		7/1984...																																		
	R5 Societe	R2382	10/75-1979																																		
	R5 TL	R1222	4/1973...																																		
	R5 USA	R1228	6/1975...																																		
	Rodeo 6	ACLIA	1973...																																		
	RENAULT-FASA (Spagna) R4	-	4/1987...																																		
	R5	-	1975-1985																																		
R7	-	-																																			
	3429	25061465 461-70 5506958 7.20934.51 816051 8448 MS-6969-S	<table border="0"> <tr> <td>OPEL</td> <td>Kadett N, S</td> <td>1000,1200 ...Mot.170258</td> <td>8/1979...</td> </tr> </table>	OPEL	Kadett N, S	1000,1200 ...Mot.170258	8/1979...																														
OPEL	Kadett N, S	1000,1200 ...Mot.170258	8/1979...																																		
	3430	7971483 XP 1483	<table border="0"> <tr> <td>VAUXHALL</td> <td>Beagle Estate 1256 cc..</td> <td></td> <td></td> </tr> <tr> <td></td> <td>Chevette 1300 -75</td> <td></td> <td></td> </tr> <tr> <td></td> <td>Viva NC 1256 cc 73-75</td> <td></td> <td></td> </tr> </table>	VAUXHALL	Beagle Estate 1256 cc..				Chevette 1300 -75				Viva NC 1256 cc 73-75																								
VAUXHALL	Beagle Estate 1256 cc..																																				
	Chevette 1300 -75																																				
	Viva NC 1256 cc 73-75																																				
	3432	AZX 1806	<table border="0"> <tr> <td>BRITISH LEYLAND</td> <td>Austin Allegro Metro</td> <td></td> <td></td> </tr> </table>	BRITISH LEYLAND	Austin Allegro Metro																																
BRITISH LEYLAND	Austin Allegro Metro																																				
	3434	AUF 702 - 800	<table border="0"> <tr> <td>BRITISH LEYLAND</td> <td>Austin Maxi 1500 - 1750 - HL 69-82</td> <td></td> <td></td> </tr> </table>	BRITISH LEYLAND	Austin Maxi 1500 - 1750 - HL 69-82																																
BRITISH LEYLAND	Austin Maxi 1500 - 1750 - HL 69-82																																				





PUMP	PTZ number	original number	application
	3435	AUF 812	BRITISH LEYLAND Metro 1000/1300 80 Mini 850/1000/1100 - Clubman-Van-1275 GT 70 1100 - 1300 - 1300 GT - MK2,3 67-74 Leyland Mini 850/1100/1100-Clubman-Van-1275 GT 75 MG 1300 67-71 Morris Ital 1300 a Van 80 Morris Marina 1,3 dal mot. 12V/H29475 12V/L17315, Van 71-80 Riley Kestrel 1100/1300 67-69 Vandel Plas 1300 67-74 Wolseley 1300 67-73
	3436	AUF 718-804	BRITISH LEYLAND Austin Allegro 1000/1100/1300 73 Austin Marina 7cwt 1100 Van 72-78 Austin Marina 7/10 cwt dal Mot. N. 12V/H29476 12V/L17316 72-78 Morris Ital 1300 80 Morris Marina 1300 dal mot. N. 12V/L29476 12V/L17316 71-80 Morris Marina 7 cwt 1100 Van 72-80
	3440	4445620 - 7564688	FIAT (Vetture) 131 - 1365, 1600 Mirafiori CL 5/81
	3441	4434839	FIAT (Vetture) 131 FL
	3442	4447943 - 5951864 - 7564842	FIAT (Vetture) Light Commercial Uno Van 1,0 OHV Uno 45 Incl. Energy Saving Eng. 903cc OHV
	3443	GE 02.0000.03	SEAT 131 1600 cc





PUMP	PTZ number	original number	application																
	3444	LF 02.0000.00	SEAT 128 1200 cc																
	3445	4435013	LANCIA Prisma 1600																
	3446	7990375	BEDFORD Chevonne 76																
	3447	AUF 817	BRITISH LEYLAND Austin 1800 MK 2,3 a 'S' 68-75 Austin (18/22 serie) 1800 75 Leyland Princess 1800 75-78 Morris 1800 MK 2,3 e'S' 68-75 Morris (18/22 serie) 1800 75																
	3448	2404 25061476 461-79 5506966 5506974 7.20934.52 816057 816061 8445 9.06.341.11 BC-151 POC 310 PK-801	<table border="0"> <tr> <td>OPEL</td> <td>Corsa ST, N, S</td> <td>1000,1200</td> <td>1983...</td> </tr> <tr> <td></td> <td>Kadett</td> <td>1000,1200 Mot. 170259...</td> <td>9/1982...</td> </tr> <tr> <td>VAUXHALL</td> <td>Astra</td> <td>1200</td> <td>1981...</td> </tr> <tr> <td></td> <td>Nova</td> <td>1100</td> <td>1983...</td> </tr> </table>	OPEL	Corsa ST, N, S	1000,1200	1983...		Kadett	1000,1200 Mot. 170259...	9/1982...	VAUXHALL	Astra	1200	1981...		Nova	1100	1983...
OPEL	Corsa ST, N, S	1000,1200	1983...																
	Kadett	1000,1200 Mot. 170259...	9/1982...																
VAUXHALL	Astra	1200	1981...																
	Nova	1100	1983...																







PUMP	PTZ number	original number	application
	3449	542140	ALFA ROMEO Alfa 33 1300 - 1600
	3450	25061429 25066363 3489003 461-83 461-94 5506956 77.00.349.266 77.00.500.194 77.00.696.974 77.01.349.266 7.21746.50 8035 8047 9.06.287.11 BC-109 LI-035 MS-60495-S PL 3047 PDC 304	OYAK (Turchia) 9 GTL - - RENAULT R11 1100,1250, 1400 1981-7/85 R11 GTS, TSE 1400 3/1983... R11 TC, GTC, Societe 1100 3/1983... R11 TL, GTL AutomaticA 1400 3/1983... R19 TR, TRE - - R9 1100, 1400 1981-7/85 R9 C, TC, GTC, TCE, L 1100 9/1981... R9 GTS, TSE, TCE,L, Autom. 1400 9/1981... R9 TL, GTL, TLE 1400 9/1981... Trafic 1397cc-Mot. 847.00 1980 RENAULT (Argentina) R9, R11 (TuTu i tipi) 1400 -
	3453	AC 461-210 AC 7971365 71241038	HILLMAN (Talbot Simca - Sumbeam) Avenger 69-73 1250-1500 Hunter Paykan Lo - Line 1598
	3455	77 00 518 857	RENAULT R6TL - Floride Caravelle 2/62







PUMP	PTZ number	original number	application
	3456	AU F-809 AC 461-293 93151056	AUSTIN Allegro 1500/1750 ...76 Princess 1500 ...75 INNOCENTI Regent 1500 74...
	3458	23100-31050 23100-39255	TOYOTA Corona (12R Eng.) 78 Hi-Lux (12 WNE) 78 Hi-Ace RH 11 (12R Eng.) 11/82... Tajo-Ace (RV) 87... Hi-Ace RH11,20,30 (12R Eng.) 1978-82 Hi-Lux RN30, 40 (12R Eng.) 78-83
	3459	23100-19215	TOYOTA Corolla KE 70E (4K Eng.) 83-- Starlet KP 60-61-62 08/81-84 (2k-2k-4k Eng.)
	3461	AUF 717	BRITISH LEYLAND Leyland Sherpa 1622/1798 cc. 74-78 Morris Marina 1,8-1,8 TC da mot. N. 18V/D/H64476 18V/E/L16556 - 18V/E/H15786 71-78
	3462	1116185 1306877 1317435 1336185 13361852 3411 463348 7.20066.00 7.20453.50 7.20799.50 8401 9.06.812.11 BC-209 PL 3401 POC 545	VOLVO 740 2000, 2300 1984-1990 240 2000, 2100, 2300 1974-1991 242, 244, 245 B 21 A 9/1974... 340 2000 1980-1984 345 2000 1985-1989 360 2000 1980-1985







PUMP	PTZ number	original number	application
	3463	77.00.728.131 77.00.276.305 77.00.726.305 77.00.728.131 77.00.734.250 7.21780.50 8744 BC-128 PL 3744 PL 8744 POC 638	RENAULT Express 950,1108,1200, 1400 - R11 1397 1986... R21 TL, GTL - R5, Van 1100,1200,1400 7/84-1993 R5 Campus R9 1100,1250,1400 8/1985... Clio 1100 Super 5 1100,1400 T.I. 1947... RENAULT-FASA (Spagna) R9, R11 - 1986...
	3469	026127 025 026127 025 A 7.20803.51 8503 POC 600	AUDI 100 Avant CC, CS, CD 1800 (75/90 PS) 1/85-8/86 100 C, CL, CS, GL 1600 (85 PS) 9/1986... 80 C, CL, GL Coupe 1300,1600 (60/85 PS) 2/85-8/86 80 GLS 1800 (90 PS) 8/82-8/86 Coupe 1800 (90 PS) 9/84-8/86 FORD (Brasile) Belina, Dei Rey, Pampa 1800 2/1991... Escort Ghia, XR-3, Verona 1800 2/1991... Pampa AP 1600 1993... Royale (Tutti i tipi) 1800, 2000- Versailles (Tutti i tipi) 1800, 2000- SEAT Toledo 1600 1991... VOLKSWAGEN Caddy Veicolo industr:1500,1600 1982... Golf S, SL, GLS Syncro 1600,1800 (72/90 PS) 11/1984... Jetta S, SL, GLS Syncro 1800 (72/90 PS) 11/1984... Passat C, CL, GL 1600, 1800 (75/90 PS) 11/1984... Santana C, CL, GL 1600,1800 (75/90 PS) 11/1984... Scirocco 1600,1800 (75/90 PS) 11/1984... VOLKSWAGEN (Brasile) Apollo, Gol, Parati 1800 2/1991... Gol, Saveiro, Parati, Voyage AP 1600 1993... Santana, Quantum, Logus 1800, 2000 2/1991... Voyage, Saveiro 1800 2/1991...
	3470	700121	FIAT (Vetture) 131 81-82
	3472	131.885 1450.77 25061452 25066428 43.106Y 461-44 5506937 7.21759.50 8114 97534887 CZ-031 PL 3114 POC 542	PEUGEOT 309 Svizzera 62 2/1986... TALBOT 1100 TI - 7/75-2/78 1307 S - 10/75-1979 1309 SX,1508,1609 SX Svezia - 7/75-8/79 1510 SX 1600 9/1979... Alpine SX, Solara 1600 1980... Horizon Premium, Solara 1600 1982... Horizon SX - 10/1978... Matra Bagheera 364 6/73-9/78 Matra Bagheera S, X 6Y41294 9/1977... Rallye II - 7/75-2/78







PUMP	PTZ number	original number	application																																																																				
	3473	13221 1450.72 1450.79 25061442 25066359 29988 34546 34.6348 461-30 5506916 55826500 55826700 7.21758.50 8101 91537966-80 97533382.80 9.06.286.11 BC-102 C7-028 PL 3101 PL 8101 POC 303 POC 624 POC 670 Re0034564	<table border="0"> <tr> <td>PEUGEOT</td> <td>205 Spagna</td> <td>EI-GI 1100,1300</td> <td>1987-1991</td> </tr> <tr> <td></td> <td>309</td> <td>EI-GI 1100,1300</td> <td>11/1985...</td> </tr> <tr> <td></td> <td>309 (Tutu i tipi)</td> <td>1100, 1300</td> <td>1987...</td> </tr> <tr> <td>TALBOT</td> <td>1500 LS, 1600 GLS</td> <td>1500, 1600</td> <td>8/1976...</td> </tr> <tr> <td></td> <td>1510</td> <td>1200, 1400</td> <td>10/75-7/79</td> </tr> <tr> <td></td> <td>Alpine (GB)</td> <td></td> <td>4/80-1986</td> </tr> <tr> <td></td> <td>Alpine, Premium</td> <td></td> <td>7/75-1986</td> </tr> <tr> <td></td> <td>Horizon LS, GL, GLS, EX</td> <td>-</td> <td>1978...</td> </tr> <tr> <td></td> <td>Horizon Premium</td> <td>-</td> <td>1982...</td> </tr> <tr> <td></td> <td>Matra Bagheera</td> <td>bY2</td> <td>10/1978...</td> </tr> <tr> <td></td> <td>Matra Murena</td> <td>1600</td> <td>9/1980...</td> </tr> <tr> <td></td> <td>Matra Rancho</td> <td>1442</td> <td>10/1977...</td> </tr> <tr> <td></td> <td>Simca 1307 GIS,S,1308 GT,S</td> <td>-</td> <td>10/1975...</td> </tr> <tr> <td></td> <td>Simca 1309 SX</td> <td>-</td> <td>10/1975...</td> </tr> <tr> <td></td> <td>Simca (no Rallye)</td> <td>1000, 1100</td> <td>10/1968...</td> </tr> <tr> <td></td> <td>Solara LS, GI, GLS, SX</td> <td>-</td> <td>4/80-1986</td> </tr> <tr> <td></td> <td>Solara (Senza ricirc.carbJ</td> <td>1600</td> <td>1982...</td> </tr> </table>	PEUGEOT	205 Spagna	EI-GI 1100,1300	1987-1991		309	EI-GI 1100,1300	11/1985...		309 (Tutu i tipi)	1100, 1300	1987...	TALBOT	1500 LS, 1600 GLS	1500, 1600	8/1976...		1510	1200, 1400	10/75-7/79		Alpine (GB)		4/80-1986		Alpine, Premium		7/75-1986		Horizon LS, GL, GLS, EX	-	1978...		Horizon Premium	-	1982...		Matra Bagheera	bY2	10/1978...		Matra Murena	1600	9/1980...		Matra Rancho	1442	10/1977...		Simca 1307 GIS,S,1308 GT,S	-	10/1975...		Simca 1309 SX	-	10/1975...		Simca (no Rallye)	1000, 1100	10/1968...		Solara LS, GI, GLS, SX	-	4/80-1986		Solara (Senza ricirc.carbJ	1600	1982...
PEUGEOT	205 Spagna	EI-GI 1100,1300	1987-1991																																																																				
	309	EI-GI 1100,1300	11/1985...																																																																				
	309 (Tutu i tipi)	1100, 1300	1987...																																																																				
TALBOT	1500 LS, 1600 GLS	1500, 1600	8/1976...																																																																				
	1510	1200, 1400	10/75-7/79																																																																				
	Alpine (GB)		4/80-1986																																																																				
	Alpine, Premium		7/75-1986																																																																				
	Horizon LS, GL, GLS, EX	-	1978...																																																																				
	Horizon Premium	-	1982...																																																																				
	Matra Bagheera	bY2	10/1978...																																																																				
	Matra Murena	1600	9/1980...																																																																				
	Matra Rancho	1442	10/1977...																																																																				
	Simca 1307 GIS,S,1308 GT,S	-	10/1975...																																																																				
	Simca 1309 SX	-	10/1975...																																																																				
	Simca (no Rallye)	1000, 1100	10/1968...																																																																				
	Solara LS, GI, GLS, SX	-	4/80-1986																																																																				
	Solara (Senza ricirc.carbJ	1600	1982...																																																																				
	3474	4434789	FIAT Regata 100 S 83																																																																				
	3475	5951673	LANCIA Beta 2 LI. 75-89																																																																				
	3476	7581117 7581119 7596676 7677589 POC 679	FIAT 126 Bis 704 1988...																																																																				
	3477	700068	BRITISH LEYLAND Austin Rover Maestro Montego 1,3 83																																																																				





PUMP	PTZ number	original number	application																																																
	3478	46618818 711228 7611465 7611466 7611466/5 7611475 8618 9.06.337.11 BC-300 POC 121 POC 605	<table border="0"> <tr> <td>FIAT</td> <td>Tempra (Carburatore)</td> <td>1400,1600</td> <td>1990-1992</td> </tr> <tr> <td></td> <td>Tipo, Tipo DGT/AGT (Carbur.)</td> <td>1400,1600</td> <td></td> </tr> <tr> <td></td> <td>Uno R89</td> <td>1370</td> <td></td> </tr> <tr> <td>YUGO</td> <td>Sana</td> <td>1372</td> <td>1987...</td> </tr> <tr> <td></td> <td>Yugo Florida</td> <td>1400,1600</td> <td></td> </tr> </table>	FIAT	Tempra (Carburatore)	1400,1600	1990-1992		Tipo, Tipo DGT/AGT (Carbur.)	1400,1600			Uno R89	1370		YUGO	Sana	1372	1987...		Yugo Florida	1400,1600																													
FIAT	Tempra (Carburatore)	1400,1600	1990-1992																																																
	Tipo, Tipo DGT/AGT (Carbur.)	1400,1600																																																	
	Uno R89	1370																																																	
YUGO	Sana	1372	1987...																																																
	Yugo Florida	1400,1600																																																	
	3479	4319578 4236973 4335818	<table border="0"> <tr> <td>ZASTAVA</td> <td>101 - 128 II serie 74</td> <td></td> <td></td> </tr> <tr> <td></td> <td>101 - 128 mot. 1116</td> <td></td> <td></td> </tr> <tr> <td></td> <td>Koral 55 mot. 1116 7/90</td> <td></td> <td></td> </tr> <tr> <td></td> <td>Skala 128 - 101</td> <td></td> <td></td> </tr> <tr> <td></td> <td>Yugo 55 mot. 1116</td> <td></td> <td></td> </tr> </table>	ZASTAVA	101 - 128 II serie 74				101 - 128 mot. 1116				Koral 55 mot. 1116 7/90				Skala 128 - 101				Yugo 55 mot. 1116																														
ZASTAVA	101 - 128 II serie 74																																																		
	101 - 128 mot. 1116																																																		
	Koral 55 mot. 1116 7/90																																																		
	Skala 128 - 101																																																		
	Yugo 55 mot. 1116																																																		
	3482	055.127.025 7.20568.00	<table border="0"> <tr> <td>VOLKSWAGEN</td> <td>Golf US (Rabbit) (1460 cc.-65 HP)</td> <td>06/78 -</td> <td></td> </tr> </table>	VOLKSWAGEN	Golf US (Rabbit) (1460 cc.-65 HP)	06/78 -																																													
VOLKSWAGEN	Golf US (Rabbit) (1460 cc.-65 HP)	06/78 -																																																	
	3484	77.00.716.997 77.00.741.339 77.00.742.566 8751 BC-200 POC 642	<table border="0"> <tr> <td>RENAULT</td> <td>Clio RL, RT</td> <td>ESF 1200</td> <td>7/1990</td> </tr> <tr> <td></td> <td>Clio RN, TR, S</td> <td>E6J 1400</td> <td>1990-1993</td> </tr> <tr> <td></td> <td>R19 GTS, RL, RN, RT, GTE</td> <td>6EJ 1400</td> <td>9/1988...</td> </tr> <tr> <td></td> <td>R19 TS, TSE</td> <td>6EJ 1400</td> <td>7/1990...</td> </tr> </table>	RENAULT	Clio RL, RT	ESF 1200	7/1990		Clio RN, TR, S	E6J 1400	1990-1993		R19 GTS, RL, RN, RT, GTE	6EJ 1400	9/1988...		R19 TS, TSE	6EJ 1400	7/1990...																																
RENAULT	Clio RL, RT	ESF 1200	7/1990																																																
	Clio RN, TR, S	E6J 1400	1990-1993																																																
	R19 GTS, RL, RN, RT, GTE	6EJ 1400	9/1988...																																																
	R19 TS, TSE	6EJ 1400	7/1990...																																																
	3485	1450.84 1455.01 1455.03 7.21760.50 8208 8209 8247 8248 8249 96118083 96145318 96145319 96145320 97522542 97531967 PL 8208 POC 603	<table border="0"> <tr> <td rowspan="10">CITROEN</td> <td>AX 10 E,10 RE, THE</td> <td>TU</td> <td>-</td> </tr> <tr> <td>AX 10,11, 14</td> <td>TU</td> <td>10/1986...</td> </tr> <tr> <td>AX 14 TZS</td> <td>TU</td> <td></td> </tr> <tr> <td>AX,11 TRE</td> <td>TU</td> <td>-</td> </tr> <tr> <td>BX 11</td> <td>1100</td> <td>1987-1991</td> </tr> <tr> <td>BX 14</td> <td>TU</td> <td>11/1988...</td> </tr> <tr> <td>C 1 5 Van</td> <td>TU 954, 1124</td> <td>10/1988...</td> </tr> <tr> <td>ZX 10,11, 14</td> <td>TU</td> <td>4/1991...</td> </tr> <tr> <td rowspan="6">PEUGEOT</td> <td>106 XN</td> <td>954 cc.</td> <td>8/1991...</td> </tr> <tr> <td>106 XR</td> <td>954-1124 cc.</td> <td>8/1991...</td> </tr> <tr> <td>106 XT</td> <td>1360 Carburatore</td> <td>8/1991...</td> </tr> <tr> <td>205,1294, Rally</td> <td>TU 950,1100, 1400</td> <td>1989...</td> </tr> <tr> <td>306 Export</td> <td>TU - 3.2</td> <td>1993...</td> </tr> <tr> <td>309</td> <td>TU 1100,1400</td> <td>7/1989...</td> </tr> <tr> <td></td> <td>405</td> <td>TU 1400</td> <td>-</td> </tr> </table>	CITROEN	AX 10 E,10 RE, THE	TU	-	AX 10,11, 14	TU	10/1986...	AX 14 TZS	TU		AX,11 TRE	TU	-	BX 11	1100	1987-1991	BX 14	TU	11/1988...	C 1 5 Van	TU 954, 1124	10/1988...	ZX 10,11, 14	TU	4/1991...	PEUGEOT	106 XN	954 cc.	8/1991...	106 XR	954-1124 cc.	8/1991...	106 XT	1360 Carburatore	8/1991...	205,1294, Rally	TU 950,1100, 1400	1989...	306 Export	TU - 3.2	1993...	309	TU 1100,1400	7/1989...		405	TU 1400	-
CITROEN	AX 10 E,10 RE, THE	TU	-																																																
	AX 10,11, 14	TU	10/1986...																																																
	AX 14 TZS	TU																																																	
	AX,11 TRE	TU	-																																																
	BX 11	1100	1987-1991																																																
	BX 14	TU	11/1988...																																																
	C 1 5 Van	TU 954, 1124	10/1988...																																																
	ZX 10,11, 14	TU	4/1991...																																																
	PEUGEOT	106 XN	954 cc.		8/1991...																																														
		106 XR	954-1124 cc.	8/1991...																																															
106 XT		1360 Carburatore	8/1991...																																																
205,1294, Rally		TU 950,1100, 1400	1989...																																																
306 Export		TU - 3.2	1993...																																																
309		TU 1100,1400	7/1989...																																																
	405	TU 1400	-																																																





PUMP	PTZ number	original number	application
	3486	10568 22F09604 C 6 174 801 8621 89BF9350 AA 89BF9350 AB BC-168 POC 606	FORD (EUROPA) Escort 1100,1300 - Escort OHV-BVM 1100,1300 - Fiesta 1000,1100,1300 9/1988... Fiesta OHV-BVM 940,1100,1300 Orion 1100,1300 9/1988... Orion OHV-BVM 1100,1300 -
	3487	23100-10020	TOYOTA Starlet (EP) (1000-1300cc-IE/ALL/ 84-- (ZE Eng.)
	3488	23100-11040	TOYOTA Corolla FWD (EE80-ZEL Eng.) 84-- Starlet (EP) (1300cc-2E/LJ/LC/EGE Eng.) 84--
	3490	AZX 1825	AUSTIN - ROVER Light commercial Maestro van 2,0 D 89-- Montego 1,6
	3491	DBP 4119	ROVER Rover Group - Rover
	3492	31700-31000	HYUNDAI Stellar 1.6 1987-1/92





PUMP	PTZ number	original number	application			
	3493	17070 - 77A27	NISSAN Sunny 1.4 (B12, N13) (GA 16S Eng.) OHC 1988-92 Sunny 1.6 (B12, N13) (GA 16S Eng.) OHC 1988-92			
	3494	2310029306	TOYOTA Canna 1.6 (TA 40,60/2T Eng.) 79-84 Corolla 1.6 (TE 70) (2T,TB Eng.) 79-83 Corolla 1.8 (TE 70) (3T Eng.) 79-83 Corolla 1.8 (TT 132) (3T Eng.) 80-81 Carina 1.6 (Ta40, 60) (2T Eng.) OHV 8/79-84			
	3495	25066259 461-379 7616989 7616990 7616991 8601 9.06.344.11 POC 120	FIAT Panda 750 CL 769 Panda 750 Super 769 Panda 750 Young 769 1987... Panda Dance 900 - SEAT Marhelo 850, 903 1988... Trans Terra 903 1985...			
	3501	77.00.670.936 PL 3035	RENAULT Traffic 847.00, 847.01,1397 10/1980...			
	3502	77.00.740.188 77.00.740.194 8743 POC 625	RENAULT Clio RL, RN C1C 956 7/1990... Clio RL, RN C1 E 1100 7/1990.. R19 Chamade TR, TRE, GTR C16 1200, C16 1400 7/1987... R19 GTR C16 1200 7/1987... R19 TR C16 1400 7/1987... R19 TR, THE C16 1200 7/1987... Supercinque TR, GTR C 1200 7/1987...			
	3570	2108.1106010 2108.910610 7.21772.50 BC-237 POC 620	LADA Carlota 1100,1300,1500 - Samara 1100,1300,1500 1987-1992			





PUMP	PTZ number	original number	application
	3572	AZX 1822	ROVER Sherpa 1.7, 2.0 (Petrol) 78-86
	3574	17010-05B25 17010-05 B00	DATSUN Mikra Canada (1200cc-MA 12 Eng) 83--
	3575	17010-0 1 B28 17010-0 1B03	DATSUN Mikra (1000cc - MA 10 Eng) 85--
	3576	20871691	SUNBEAM 1.0 OHV 1977-82
	3578	20871600 20871691 AC461-288 93151004	SUNBEAM (Chrysler - G.B.) 1.0 (930) 77-82
	3589	6488776	FORD (HCS) Man. 2 tubes Fiesta MKIII 1.1, 1.3 OHV (HCS) Man. 2 tubes 08/70-92 Escort MK IV, V 1.1, 1.3 OHV





PUMP	PTZ number	original number	application
	4220	107.111.2002.9 - APG PE 14849	BMW 700 - mod. 107/32 HP dal 59
	4221*	107.111.2010.9 - APG PE 14886	BMW 700 - mod. 107/40 HP dal 61
	4222	133.106.8000	BMW 1500/1800
	4223	7.15059.50 - 115.111.2000.3 7.15581.50 - 125.2506.3 7.15520.50 - 118.111.2000.3	BMW 1500 (80 HP) 59-1/65 1600 (83 HP) 59-4/64 1602 - 1600 (85 HP) 3/66-7/73 1800 (90 HP) 63-9/72 1802 - 1800 (90 HP) 9/70-7/73 1800 mot. Marino (90 HP) 4/66 2000 mot. Marino (100 HP) 1/68
	4224	7.15517.50 - 121.111.2001.3 7.1574.50 - 125.2586.3 132.5056.9 - 1331.1325.065 132.5243.9 - 7.15561.50 - 7.15584.00	BMW 1800 TI (110 HP) 64-7/68 2000 Aut. (100 HP) 66-9/72 2000 TI (120 HP) 8/65-7/71 2002 - 2000 (100 HP) 1/68-8/73
	4225	7.15518.50 1251.055.3 7.20138.50 - 1260.677.2 7.20810.51 - 1331.1260.677 1331.1251.055	BMW 525/2500 (145 HP) 9/73-8/76 528/2500 (165 HP) 2/75-6/76 2500 (150 HP) 9/68-1/77 2800 (170 HP) 9/68-1/77 3000 (180 HP) 4/71-1/77 3300 (190 HP) 7/74-9/75





PUMP	PTZ number	original number	application																																																																																																				
	4242	132.211 25061453 3312 3314 461-45 5428535 5428536 5428537 5467097 5491102 5506938 75492254 7.21767.50 8109 8312 8314 95493324 95493367 95648551 9.06.800.11 BC-110 CZ-052 GX 0314502 A GX 0314503 A PV 3109 PV 3312	<table border="0"> <tr> <td>CITROEN</td> <td>Ami 8 Super</td> <td>1015,1130,1270</td> <td>9/70-1976</td> </tr> <tr> <td></td> <td>Axel "11 R"</td> <td>1129</td> <td>7/1984...</td> </tr> <tr> <td></td> <td>Axel "12 R"</td> <td>1295</td> <td>7/1984...</td> </tr> <tr> <td></td> <td>Enterprise</td> <td>1129</td> <td>1980...</td> </tr> <tr> <td></td> <td>GS 1015, GS 1220, GS X3</td> <td>-</td> <td>9/1970...</td> </tr> <tr> <td></td> <td>GSA Special, Break Special</td> <td>1129</td> <td>1980...</td> </tr> <tr> <td></td> <td>GS, GSA, GX, GSX</td> <td>-</td> <td>9/1970...</td> </tr> <tr> <td>OLTCIT (Romania)</td> <td>Axel 11 R -12R</td> <td>1129cc - 4 cil Citroen</td> <td>1981...</td> </tr> <tr> <td></td> <td>Club 11 R,12TR5</td> <td>1297</td> <td>-</td> </tr> </table>	CITROEN	Ami 8 Super	1015,1130,1270	9/70-1976		Axel "11 R"	1129	7/1984...		Axel "12 R"	1295	7/1984...		Enterprise	1129	1980...		GS 1015, GS 1220, GS X3	-	9/1970...		GSA Special, Break Special	1129	1980...		GS, GSA, GX, GSX	-	9/1970...	OLTCIT (Romania)	Axel 11 R -12R	1129cc - 4 cil Citroen	1981...		Club 11 R,12TR5	1297	-																																																																
CITROEN	Ami 8 Super	1015,1130,1270	9/70-1976																																																																																																				
	Axel "11 R"	1129	7/1984...																																																																																																				
	Axel "12 R"	1295	7/1984...																																																																																																				
	Enterprise	1129	1980...																																																																																																				
	GS 1015, GS 1220, GS X3	-	9/1970...																																																																																																				
	GSA Special, Break Special	1129	1980...																																																																																																				
	GS, GSA, GX, GSX	-	9/1970...																																																																																																				
OLTCIT (Romania)	Axel 11 R -12R	1129cc - 4 cil Citroen	1981...																																																																																																				
	Club 11 R,12TR5	1297	-																																																																																																				
	4246	25061455 25066371 3313 461-47 5437616 5437945 5506940 8313 PV 3313	<table border="0"> <tr> <td>CITROEN</td> <td>C 35</td> <td>Benzina</td> <td>1978...</td> </tr> <tr> <td></td> <td>CX</td> <td>2000, 2200, 2400</td> <td>10/1974...</td> </tr> </table>	CITROEN	C 35	Benzina	1978...		CX	2000, 2200, 2400	10/1974...																																																																																												
CITROEN	C 35	Benzina	1978...																																																																																																				
	CX	2000, 2200, 2400	10/1974...																																																																																																				
	4265	2101.1106010 4163954 9.06.121.11	<table border="0"> <tr> <td>LADA</td> <td>21043 Station Wagon</td> <td>1500</td> <td>-</td> </tr> <tr> <td></td> <td>2105</td> <td>1200,1300, 1500</td> <td>1973-1986</td> </tr> <tr> <td></td> <td>2107</td> <td>1300,1500,1600</td> <td>1978-1984</td> </tr> <tr> <td></td> <td>Niva</td> <td>1600</td> <td></td> </tr> </table>	LADA	21043 Station Wagon	1500	-		2105	1200,1300, 1500	1973-1986		2107	1300,1500,1600	1978-1984		Niva	1600																																																																																					
LADA	21043 Station Wagon	1500	-																																																																																																				
	2105	1200,1300, 1500	1973-1986																																																																																																				
	2107	1300,1500,1600	1978-1984																																																																																																				
	Niva	1600																																																																																																					
	4271	25061450 3443 461-38 461-41 461-57 5506901 5506925 5506932 7.15501.50 7.15603.50 7.15656.50 7.20971.52 816030 816031 816035 816036 816047 8443 8930335 BC-149 FPM-036 G 6932 GFP 4271 N POC 307 PX-800	<table border="0"> <tr> <td>HOLDEN</td> <td>Torana Subird 1900</td> <td>Opel</td> <td>1974-1978</td> </tr> <tr> <td>OPEL</td> <td>Admiral B</td> <td>2800 H/S</td> <td>1969-7/77</td> </tr> <tr> <td></td> <td>Ascona A, B, N, S</td> <td>1600, 1900, 2000</td> <td>8/70-9/81</td> </tr> <tr> <td></td> <td>Blitz, LKW</td> <td>2500</td> <td>1966...</td> </tr> <tr> <td></td> <td>Commodore</td> <td>2200, 2500 S, 2800 H/S</td> <td>1967-1977</td> </tr> <tr> <td></td> <td>Diplomat B</td> <td>2800 H/S</td> <td>1969-7/77</td> </tr> <tr> <td></td> <td>Kadett S, GT</td> <td>1600, 1900</td> <td>1969-8/79</td> </tr> <tr> <td></td> <td>Kadett, Olympia</td> <td>1900</td> <td>8/65-3/71</td> </tr> <tr> <td></td> <td>Kapitan</td> <td>2800</td> <td>1969-7/77</td> </tr> <tr> <td></td> <td>Manta B 1,6N/S-1,9 S-2,0N/S</td> <td>1600, 1900, 2000</td> <td>8/70-9/81</td> </tr> <tr> <td></td> <td>Monza</td> <td>2800</td> <td>10/67-8/82</td> </tr> <tr> <td></td> <td>Monza</td> <td>2800H</td> <td>1978...</td> </tr> <tr> <td></td> <td>Monza</td> <td>3000H</td> <td>1978...</td> </tr> <tr> <td></td> <td>Rekord</td> <td>1700,1900, 2000</td> <td>3/1971...</td> </tr> <tr> <td></td> <td>Rekord</td> <td>2200</td> <td>1967-1968</td> </tr> <tr> <td></td> <td>Senator</td> <td>2800</td> <td>10/67-8/82</td> </tr> <tr> <td></td> <td>Senator</td> <td>2800H</td> <td>1978...</td> </tr> <tr> <td></td> <td>Senator</td> <td>3000H</td> <td>1978...</td> </tr> <tr> <td>PONTIAC (USA)</td> <td>Le Mans (DAEWOO)</td> <td>Opel 1900</td> <td>1974-1978</td> </tr> <tr> <td>RANGER</td> <td>S, SH</td> <td>1700,1900, 2500, 2800</td> <td>1972-8/77</td> </tr> <tr> <td>VAUXHALL</td> <td>Carlton S, Viceroy</td> <td>2000, 2500</td> <td>9/78-1982</td> </tr> <tr> <td></td> <td>Cavalier S</td> <td>1600, 1900, 2000</td> <td>1975-1981</td> </tr> <tr> <td></td> <td>Royale</td> <td>2800</td> <td>10/78-1983</td> </tr> <tr> <td></td> <td>Senator</td> <td></td> <td>1984...</td> </tr> <tr> <td>GMH, Holden</td> <td>Torana Sunbird LX Opel</td> <td></td> <td>1974-78</td> </tr> </table>	HOLDEN	Torana Subird 1900	Opel	1974-1978	OPEL	Admiral B	2800 H/S	1969-7/77		Ascona A, B, N, S	1600, 1900, 2000	8/70-9/81		Blitz, LKW	2500	1966...		Commodore	2200, 2500 S, 2800 H/S	1967-1977		Diplomat B	2800 H/S	1969-7/77		Kadett S, GT	1600, 1900	1969-8/79		Kadett, Olympia	1900	8/65-3/71		Kapitan	2800	1969-7/77		Manta B 1,6N/S-1,9 S-2,0N/S	1600, 1900, 2000	8/70-9/81		Monza	2800	10/67-8/82		Monza	2800H	1978...		Monza	3000H	1978...		Rekord	1700,1900, 2000	3/1971...		Rekord	2200	1967-1968		Senator	2800	10/67-8/82		Senator	2800H	1978...		Senator	3000H	1978...	PONTIAC (USA)	Le Mans (DAEWOO)	Opel 1900	1974-1978	RANGER	S, SH	1700,1900, 2500, 2800	1972-8/77	VAUXHALL	Carlton S, Viceroy	2000, 2500	9/78-1982		Cavalier S	1600, 1900, 2000	1975-1981		Royale	2800	10/78-1983		Senator		1984...	GMH, Holden	Torana Sunbird LX Opel		1974-78
HOLDEN	Torana Subird 1900	Opel	1974-1978																																																																																																				
OPEL	Admiral B	2800 H/S	1969-7/77																																																																																																				
	Ascona A, B, N, S	1600, 1900, 2000	8/70-9/81																																																																																																				
	Blitz, LKW	2500	1966...																																																																																																				
	Commodore	2200, 2500 S, 2800 H/S	1967-1977																																																																																																				
	Diplomat B	2800 H/S	1969-7/77																																																																																																				
	Kadett S, GT	1600, 1900	1969-8/79																																																																																																				
	Kadett, Olympia	1900	8/65-3/71																																																																																																				
	Kapitan	2800	1969-7/77																																																																																																				
	Manta B 1,6N/S-1,9 S-2,0N/S	1600, 1900, 2000	8/70-9/81																																																																																																				
	Monza	2800	10/67-8/82																																																																																																				
	Monza	2800H	1978...																																																																																																				
	Monza	3000H	1978...																																																																																																				
	Rekord	1700,1900, 2000	3/1971...																																																																																																				
	Rekord	2200	1967-1968																																																																																																				
	Senator	2800	10/67-8/82																																																																																																				
	Senator	2800H	1978...																																																																																																				
	Senator	3000H	1978...																																																																																																				
PONTIAC (USA)	Le Mans (DAEWOO)	Opel 1900	1974-1978																																																																																																				
RANGER	S, SH	1700,1900, 2500, 2800	1972-8/77																																																																																																				
VAUXHALL	Carlton S, Viceroy	2000, 2500	9/78-1982																																																																																																				
	Cavalier S	1600, 1900, 2000	1975-1981																																																																																																				
	Royale	2800	10/78-1983																																																																																																				
	Senator		1984...																																																																																																				
GMH, Holden	Torana Sunbird LX Opel		1974-78																																																																																																				







PUMP	PTZ number	original number	application																																																										
	4282	APG PE 15127 - 15559 - 14991 11.425.629 - 11.712.073	<table border="0"> <tr> <td rowspan="5">FORD</td> <td>Taurus 17M</td> <td>1500/1700</td> <td>64-67</td> </tr> <tr> <td>Taurus 12M/15 M</td> <td>1200/1300/1500</td> <td>66-70</td> </tr> <tr> <td>Transit (benzina)</td> <td>1700 mot. 4 cil. a V</td> <td>64-65</td> </tr> <tr> <td>Taurus 12M</td> <td>2000 con mot. 6 cil. a V</td> <td>64-66</td> </tr> <tr> <td>Taurus 12M</td> <td>1700</td> <td>67-70</td> </tr> </table>	FORD	Taurus 17M	1500/1700	64-67	Taurus 12M/15 M	1200/1300/1500	66-70	Transit (benzina)	1700 mot. 4 cil. a V	64-65	Taurus 12M	2000 con mot. 6 cil. a V	64-66	Taurus 12M	1700	67-70																																										
FORD	Taurus 17M	1500/1700	64-67																																																										
	Taurus 12M/15 M	1200/1300/1500	66-70																																																										
	Transit (benzina)	1700 mot. 4 cil. a V	64-65																																																										
	Taurus 12M	2000 con mot. 6 cil. a V	64-66																																																										
	Taurus 12M	1700	67-70																																																										
	4283	D3 FZ 9350 A APG PE 20201 - 5506923 70 HF 9350 CA - 461.36 76 HF 9350 AA - 72 HF 9250 AA 1 535 554 1 562 589 11 712 073 6 090 510 6 097 538 6146 183 75HF9350 AA 76HF9350 AB 81 SF9350 DB 81 SF9350 FA 84BR9350 C 25061314 7.20828.51 - 7.20828.59	<table border="0"> <tr> <td rowspan="20">FORD</td> <td>Taurus 15M</td> <td>1700 (70/75 HP) 4V</td> <td>10/67-12/71</td> </tr> <tr> <td>Capri</td> <td>1300 - 1600 4 cil.</td> <td>4/70</td> </tr> <tr> <td>Consul</td> <td>2000 4 cil. (90 HP)</td> <td>4/70-8/79</td> </tr> <tr> <td>Taurus</td> <td>1300-1600 4 cil.</td> <td>4/70</td> </tr> <tr> <td>Capri</td> <td>1300-1500-1700 (4V) (OHV)</td> <td>10/67-71</td> </tr> <tr> <td>Cortina</td> <td>1600-2000 4 cil.</td> <td>77</td> </tr> <tr> <td>Cortina</td> <td>2000 (USA)</td> <td>71-8/82</td> </tr> <tr> <td>Cortina MK3</td> <td>1600-2000 GT (OHC)</td> <td>70-76</td> </tr> <tr> <td>Escort</td> <td>1100-1300-1600 4 cil. (OHC)</td> <td>9/80</td> </tr> <tr> <td>Escort XR3</td> <td></td> <td>1982</td> </tr> <tr> <td>Fiesta</td> <td>1000-1100-1300 4 cil. (OHC)</td> <td>76</td> </tr> <tr> <td>Fiesta XR2</td> <td>1600 (OHC)</td> <td>4/84</td> </tr> <tr> <td>Granada</td> <td>2000</td> <td>9/79</td> </tr> <tr> <td>Orion</td> <td>1300-1600 (OHC)</td> <td>9/83-8/88</td> </tr> <tr> <td>Scorpio</td> <td>1800-2000 (OHC)</td> <td>4/85</td> </tr> <tr> <td>Sierra</td> <td>1600-1800-2000 4 cil. (OHC)</td> <td>9/82</td> </tr> <tr> <td>Transit</td> <td>1600-2000 4 cil. (OHC)</td> <td>9/84</td> </tr> <tr> <td>Cortina TC, TD, TE, TF</td> <td>2000</td> <td>1971-81</td> </tr> <tr> <td>Escort</td> <td></td> <td>1976-82</td> </tr> </table>	FORD	Taurus 15M	1700 (70/75 HP) 4V	10/67-12/71	Capri	1300 - 1600 4 cil.	4/70	Consul	2000 4 cil. (90 HP)	4/70-8/79	Taurus	1300-1600 4 cil.	4/70	Capri	1300-1500-1700 (4V) (OHV)	10/67-71	Cortina	1600-2000 4 cil.	77	Cortina	2000 (USA)	71-8/82	Cortina MK3	1600-2000 GT (OHC)	70-76	Escort	1100-1300-1600 4 cil. (OHC)	9/80	Escort XR3		1982	Fiesta	1000-1100-1300 4 cil. (OHC)	76	Fiesta XR2	1600 (OHC)	4/84	Granada	2000	9/79	Orion	1300-1600 (OHC)	9/83-8/88	Scorpio	1800-2000 (OHC)	4/85	Sierra	1600-1800-2000 4 cil. (OHC)	9/82	Transit	1600-2000 4 cil. (OHC)	9/84	Cortina TC, TD, TE, TF	2000	1971-81	Escort		1976-82
FORD	Taurus 15M	1700 (70/75 HP) 4V	10/67-12/71																																																										
	Capri	1300 - 1600 4 cil.	4/70																																																										
	Consul	2000 4 cil. (90 HP)	4/70-8/79																																																										
	Taurus	1300-1600 4 cil.	4/70																																																										
	Capri	1300-1500-1700 (4V) (OHV)	10/67-71																																																										
	Cortina	1600-2000 4 cil.	77																																																										
	Cortina	2000 (USA)	71-8/82																																																										
	Cortina MK3	1600-2000 GT (OHC)	70-76																																																										
	Escort	1100-1300-1600 4 cil. (OHC)	9/80																																																										
	Escort XR3		1982																																																										
	Fiesta	1000-1100-1300 4 cil. (OHC)	76																																																										
	Fiesta XR2	1600 (OHC)	4/84																																																										
	Granada	2000	9/79																																																										
	Orion	1300-1600 (OHC)	9/83-8/88																																																										
	Scorpio	1800-2000 (OHC)	4/85																																																										
	Sierra	1600-1800-2000 4 cil. (OHC)	9/82																																																										
	Transit	1600-2000 4 cil. (OHC)	9/84																																																										
	Cortina TC, TD, TE, TF	2000	1971-81																																																										
	Escort		1976-82																																																										
		4284	APG PE 15537 - 20009 11.448299 - 69 EN 9350 AA	<table border="0"> <tr> <td rowspan="3">FORD</td> <td>Taurus 17M - 20M</td> <td>1800/2000 6 cil. A V</td> <td></td> </tr> <tr> <td>Capri</td> <td>1300/1500/1700</td> <td></td> </tr> <tr> <td>Consul 1700 - Transit</td> <td>1200/1300/1500/1700 mot. 4 cil. a V</td> <td></td> </tr> </table>	FORD	Taurus 17M - 20M	1800/2000 6 cil. A V		Capri	1300/1500/1700		Consul 1700 - Transit	1200/1300/1500/1700 mot. 4 cil. a V																																																
FORD	Taurus 17M - 20M	1800/2000 6 cil. A V																																																											
	Capri	1300/1500/1700																																																											
	Consul 1700 - Transit	1200/1300/1500/1700 mot. 4 cil. a V																																																											
	4285	1235900 1238590 1238591 1240098 25061260 25061517 25061553 25061560 461-156 461-157 461-196 461-241 461-257 71261471 717180116 71804059 71804116 7971009 7971010 7971275 7990052 7990149 8120 A0-055	<table border="0"> <tr> <td>PAYKAN</td> <td>Paykan</td> <td>Talbot Number</td> <td>...1990</td> </tr> <tr> <td>TALBOT</td> <td>Commer PA</td> <td>1500, 2500</td> <td>1965-1970</td> </tr> <tr> <td></td> <td>Commer PB Eurgone</td> <td>4 Cil.</td> <td>1967...</td> </tr> <tr> <td></td> <td>Dodge PB Purgone</td> <td>4 Cil.</td> <td>1967...</td> </tr> <tr> <td></td> <td>Hillman Estate</td> <td>-</td> <td>1966-1970</td> </tr> <tr> <td></td> <td>Hillman Hunter, GT</td> <td>-</td> <td>1966-1978</td> </tr> <tr> <td></td> <td>Hillman Husky III</td> <td>-</td> <td>1965-1970</td> </tr> <tr> <td></td> <td>Hillman Minx, Super Minx</td> <td>1.7 OHV</td> <td>1966-1970</td> </tr> <tr> <td></td> <td>Humber Sceptre</td> <td>-</td> <td>1966-1976</td> </tr> <tr> <td></td> <td>Sceptre H120 c/alternatore</td> <td>1.7 Lit./OHV 1725cc</td> <td>...1976</td> </tr> <tr> <td></td> <td>Singer Gazelle VI - Vogue</td> <td>1.5 OHV</td> <td>1966-1973</td> </tr> <tr> <td></td> <td>Sunbeam Alpine, H120, Rapier V</td> <td>1.7 OHV</td> <td>1965-1976</td> </tr> <tr> <td></td> <td>Sunbeam Hunter</td> <td>1.5, 1.7 OHV</td> <td>1972...</td> </tr> <tr> <td></td> <td>Sunbeam Rapier</td> <td>1.7 lit./OHV 1725cc</td> <td>..1976</td> </tr> </table>	PAYKAN	Paykan	Talbot Number	...1990	TALBOT	Commer PA	1500, 2500	1965-1970		Commer PB Eurgone	4 Cil.	1967...		Dodge PB Purgone	4 Cil.	1967...		Hillman Estate	-	1966-1970		Hillman Hunter, GT	-	1966-1978		Hillman Husky III	-	1965-1970		Hillman Minx, Super Minx	1.7 OHV	1966-1970		Humber Sceptre	-	1966-1976		Sceptre H120 c/alternatore	1.7 Lit./OHV 1725cc	...1976		Singer Gazelle VI - Vogue	1.5 OHV	1966-1973		Sunbeam Alpine, H120, Rapier V	1.7 OHV	1965-1976		Sunbeam Hunter	1.5, 1.7 OHV	1972...		Sunbeam Rapier	1.7 lit./OHV 1725cc	..1976		
PAYKAN	Paykan	Talbot Number	...1990																																																										
TALBOT	Commer PA	1500, 2500	1965-1970																																																										
	Commer PB Eurgone	4 Cil.	1967...																																																										
	Dodge PB Purgone	4 Cil.	1967...																																																										
	Hillman Estate	-	1966-1970																																																										
	Hillman Hunter, GT	-	1966-1978																																																										
	Hillman Husky III	-	1965-1970																																																										
	Hillman Minx, Super Minx	1.7 OHV	1966-1970																																																										
	Humber Sceptre	-	1966-1976																																																										
	Sceptre H120 c/alternatore	1.7 Lit./OHV 1725cc	...1976																																																										
	Singer Gazelle VI - Vogue	1.5 OHV	1966-1973																																																										
	Sunbeam Alpine, H120, Rapier V	1.7 OHV	1965-1976																																																										
	Sunbeam Hunter	1.5, 1.7 OHV	1972...																																																										
	Sunbeam Rapier	1.7 lit./OHV 1725cc	..1976																																																										







PUMP	PTZ number	original number	application																																												
	4285/1	25169700	PAYKAN - TEHERAN 1725																																												
	4288	AP6 PE 20202 76 TF 9350 CA - 72 TF 9350 AB	FORD Capri 1300/1500/1700 (4V) - Consul 1700 (75 HP) Granada 1700 (70/75 HP) (4V) 1/72 Transit 1500/1700 (4V) 1 /72-3/73																																												
	4291 3291 + the crank for handle	1450.11 791002069 1450.14 7.21747.50 1450.16 8202 1450.22 8203 1450.30 8205 1450.71 8224 1450.76 91501190 25061444 BC-106 25066362 C7-055 3224 PL 3202 461-27 PL 3203 461-32 PI 3205 5506913 PL 3252 5506918 PI 3255 7910000321 POC 311 POC 527	<table border="0"> <tr> <td>CITROEN</td> <td>C 25</td> <td>1800, 2000 (Benzina)</td> <td>9/1982...</td> </tr> <tr> <td>PEUGEOT</td> <td>203</td> <td>-</td> <td>-</td> </tr> <tr> <td></td> <td>403/7, 403</td> <td>-</td> <td>...2/1961</td> </tr> <tr> <td></td> <td>404</td> <td>1600</td> <td>3/ 1960...</td> </tr> <tr> <td></td> <td>504 L, GL, GR, SR, S</td> <td>1800, 2000</td> <td>10/1968...</td> </tr> <tr> <td></td> <td>505 GL, GR, SR</td> <td>1800, 2000</td> <td>5/1979...</td> </tr> <tr> <td></td> <td>D3A-D4A-VAN</td> <td>-</td> <td>-</td> </tr> <tr> <td></td> <td>J 5</td> <td>XNVA, XN8-Benzina</td> <td>11/81-8/82</td> </tr> <tr> <td></td> <td>J 7</td> <td>Benzina</td> <td>1965...</td> </tr> <tr> <td></td> <td>J 9</td> <td>Benzina 1600, 2000</td> <td>1/1980...</td> </tr> <tr> <td></td> <td>Jeep P 4</td> <td>Benzina</td> <td>1981-8/82</td> </tr> </table>	CITROEN	C 25	1800, 2000 (Benzina)	9/1982...	PEUGEOT	203	-	-		403/7, 403	-	...2/1961		404	1600	3/ 1960...		504 L, GL, GR, SR, S	1800, 2000	10/1968...		505 GL, GR, SR	1800, 2000	5/1979...		D3A-D4A-VAN	-	-		J 5	XNVA, XN8-Benzina	11/81-8/82		J 7	Benzina	1965...		J 9	Benzina 1600, 2000	1/1980...		Jeep P 4	Benzina	1981-8/82
CITROEN	C 25	1800, 2000 (Benzina)	9/1982...																																												
PEUGEOT	203	-	-																																												
	403/7, 403	-	...2/1961																																												
	404	1600	3/ 1960...																																												
	504 L, GL, GR, SR, S	1800, 2000	10/1968...																																												
	505 GL, GR, SR	1800, 2000	5/1979...																																												
	D3A-D4A-VAN	-	-																																												
	J 5	XNVA, XN8-Benzina	11/81-8/82																																												
	J 7	Benzina	1965...																																												
	J 9	Benzina 1600, 2000	1/1980...																																												
	Jeep P 4	Benzina	1981-8/82																																												
	4292 3292 + the crank for handle	1450.17 1450.27 1450.31 1450.32 1450.53 1450.75 25061473 3201 461-56	<table border="0"> <tr> <td>PEUGEOT</td> <td>204</td> <td>1100</td> <td>1965-1976</td> </tr> <tr> <td></td> <td>304, 304 S</td> <td>1100,1300</td> <td>10/68-1979</td> </tr> <tr> <td></td> <td>305 GL, GR, SR, S</td> <td>1300,1500</td> <td>12/1977...</td> </tr> <tr> <td></td> <td>403/8</td> <td>-</td> <td>...2/1961</td> </tr> <tr> <td></td> <td>403/U</td> <td>-</td> <td>12/1960...</td> </tr> </table>	PEUGEOT	204	1100	1965-1976		304, 304 S	1100,1300	10/68-1979		305 GL, GR, SR, S	1300,1500	12/1977...		403/8	-	...2/1961		403/U	-	12/1960...																								
PEUGEOT	204	1100	1965-1976																																												
	304, 304 S	1100,1300	10/68-1979																																												
	305 GL, GR, SR, S	1300,1500	12/1977...																																												
	403/8	-	...2/1961																																												
	403/U	-	12/1960...																																												
	4294	1450.35 1450.43 1450.44 25061459 25066364 269627-6 3032 3211 3213 3517422 461-48 461-53 5506941 5506950 74.00.269.627 7910245706 79.10.245.706	<table border="0"> <tr> <td>PEUGEOT</td> <td>504 Coupe, Cabriolet</td> <td>V6</td> <td>10/1974...</td> </tr> <tr> <td></td> <td>604 Cabriolet, Coupe PF</td> <td>-</td> <td>1/1978,...</td> </tr> <tr> <td></td> <td>604 SL</td> <td>V6</td> <td>10/1975...</td> </tr> <tr> <td>RENAULT</td> <td>Alpine A 310</td> <td>V6</td> <td>1976...</td> </tr> <tr> <td></td> <td>R30 TS, TX</td> <td>R1273, R1275</td> <td>10/76-1983</td> </tr> <tr> <td>TALBOT</td> <td>Tagora VS, SX</td> <td>-</td> <td>1981...</td> </tr> <tr> <td>VOLVO</td> <td>240, 260</td> <td>B 27</td> <td>-</td> </tr> <tr> <td></td> <td>264 DL, GL</td> <td>V6</td> <td>9/1974...</td> </tr> <tr> <td></td> <td>740, 760</td> <td>B 27</td> <td>-</td> </tr> </table>	PEUGEOT	504 Coupe, Cabriolet	V6	10/1974...		604 Cabriolet, Coupe PF	-	1/1978,...		604 SL	V6	10/1975...	RENAULT	Alpine A 310	V6	1976...		R30 TS, TX	R1273, R1275	10/76-1983	TALBOT	Tagora VS, SX	-	1981...	VOLVO	240, 260	B 27	-		264 DL, GL	V6	9/1974...		740, 760	B 27	-								
PEUGEOT	504 Coupe, Cabriolet	V6	10/1974...																																												
	604 Cabriolet, Coupe PF	-	1/1978,...																																												
	604 SL	V6	10/1975...																																												
RENAULT	Alpine A 310	V6	1976...																																												
	R30 TS, TX	R1273, R1275	10/76-1983																																												
TALBOT	Tagora VS, SX	-	1981...																																												
VOLVO	240, 260	B 27	-																																												
	264 DL, GL	V6	9/1974...																																												
	740, 760	B 27	-																																												







PUMP	PTZ number	original number	application
	4295 3295 + the crank for handle	1450.11 - Guiot 524	PEUGEOT 403/7 - 2/61
	4302	001 091 69 01 001 091 79 01 002 091 02 01 002 091 11 01 002 091 65 01 115 090 01 50 115 090 02 44 25066425 461-278 7.15673.50 7.20015.50 7.20102.50 7.20174.50 7.20797.50 7.20874.50 8811 9.06.813.11 BC-211 POC 519	MERCEDES-BENZ 200/W123-M115 2000 (95 PS) 1/71-7/80 220/W123-M115 2200 (105 PS) 1/1971... 230 G-M115 2307 (90/102 PS) 1/1979... 230,230/6,230/4,230/W123 2300 (109/110/120 PS) 1/1971... 250, 250/W123 2500 (129/130 PS) 1/1971... 280 2800 (160 PS) 3/72-9/76 280 S 2800 (140 PS) 1/68-2/72 280/W123 2800 (156 PS) 9/1975... L 208, 308 2300 (90 PS) 1/1977... L 319 B 1900, 2000 (68/80 PS) 7/1971... L 408 2200 (75/85 PS) 7/71-8/75 L 409 2300 (90 PS) 9/1975... L 601 2.3 lit. 1977-1982 Unimog L 404 S 2200, 2800 (85/110 PS) 1/1972...
	4314	08.55.952.800 25061437 25066367 3003 461-25 5506910 77.00.557.763 77.00.641.717 77.01.348.155 7.21739.50 9.06.801.11 BC-191 POC 546 PV 3003	RENAULT Alpine A 110, 310 R16 TS/TX 1968-1976 Fuego TS, GTS e Automatica R1362, 81368 3/80-1985 R12 Gordini R1173 10/70-1974 R15 TS, TA R1302 10/71-9/76 R16 TS, TA, TX R1151, R1154, R1156 1968-6/76 R17 TL, TS R1312, R1318, R1322, R1328 1972-1978 R18 Export GTS R1348, R1358, 1342, 1352 3/80-1986 R20 L, TL, GTL 1600 (81271) 12/75-1983
	4318 3318 + the crank for handle	25061449 25066413 461-40 5506931 77.00.520.928 77.00.544.500 77.00.634.554 77.01.348.614 8014 11-003 PL 3014	RENAULT R4 Break 82370, 82330, 82430 4/1975... R4 Furgonette F6 - 1961-1981 R4 TL, Rodeo, R4 F6 - 4/1975... R4, R4 GTL 81128 1/1978... R6 TL R 1181 10/70-1980







PUMP	PTZ number	original number	application																																					
	4319	25061431 25061458 25066368 25066372 3031 3039 3489006 3732 461-52 461-96 5506948 77.00.737 700 77.00.349.261 77.00.625.707 77.00.641.069 77.00.646.555 77.00.646.959 77.00.690.476 77.00.690.477 77.00.720.476 77.01.348.261 77.01.349.080 77.01.349.261 7.21741.50 7.21743.50 7.21756.50 9.06.806.11 9.06.809.11 BC-192 BC-194 POC 536 PV 3031 PV 3039 PV 3732	<table border="0"> <tr> <td rowspan="15">RENAULT</td> <td>Espace GTX, TX, TSE</td> <td>2000</td> <td>7/1984...</td> </tr> <tr> <td>Fuego</td> <td>R1363 2.0 lit.</td> <td>1982-1985</td> </tr> <tr> <td>Fuego TX, GTX Aut.</td> <td>R1263</td> <td>1980...</td> </tr> <tr> <td>Jeep CJ7</td> <td>1995</td> <td>5/1983...</td> </tr> <tr> <td>Master</td> <td>829.730, 829.731</td> <td>10/1980...</td> </tr> <tr> <td>R18 Export GTS,GTX,TX,BREAK</td> <td>2000 (R1343)</td> <td>3/1980...</td> </tr> <tr> <td>R20</td> <td>R1272, R1277</td> <td>1980-1983</td> </tr> <tr> <td>R20 LS, TS, TX, Automatica</td> <td>2000, R1279</td> <td>1977...</td> </tr> <tr> <td>R25 GTS, TS, TX</td> <td>2000 - B297</td> <td>1984...</td> </tr> <tr> <td>Traffic T1300B, P1400B</td> <td>-</td> <td>5/1983...</td> </tr> <tr> <td>Traffic, Microcar Minibus</td> <td>1200cc, 1400cc</td> <td>1987-1992</td> </tr> <tr> <td>RENAULT (Argentina) R18 Fuego</td> <td>2000</td> <td>-</td> </tr> </table>	RENAULT	Espace GTX, TX, TSE	2000	7/1984...	Fuego	R1363 2.0 lit.	1982-1985	Fuego TX, GTX Aut.	R1263	1980...	Jeep CJ7	1995	5/1983...	Master	829.730, 829.731	10/1980...	R18 Export GTS,GTX,TX,BREAK	2000 (R1343)	3/1980...	R20	R1272, R1277	1980-1983	R20 LS, TS, TX, Automatica	2000, R1279	1977...	R25 GTS, TS, TX	2000 - B297	1984...	Traffic T1300B, P1400B	-	5/1983...	Traffic, Microcar Minibus	1200cc, 1400cc	1987-1992	RENAULT (Argentina) R18 Fuego	2000	-
RENAULT	Espace GTX, TX, TSE	2000	7/1984...																																					
	Fuego	R1363 2.0 lit.	1982-1985																																					
	Fuego TX, GTX Aut.	R1263	1980...																																					
	Jeep CJ7	1995	5/1983...																																					
	Master	829.730, 829.731	10/1980...																																					
	R18 Export GTS,GTX,TX,BREAK	2000 (R1343)	3/1980...																																					
	R20	R1272, R1277	1980-1983																																					
	R20 LS, TS, TX, Automatica	2000, R1279	1977...																																					
	R25 GTS, TS, TX	2000 - B297	1984...																																					
	Traffic T1300B, P1400B	-	5/1983...																																					
	Traffic, Microcar Minibus	1200cc, 1400cc	1987-1992																																					
	RENAULT (Argentina) R18 Fuego	2000	-																																					
		4357	162.059 25061438 25066366 40.961 H 461-26 5506911		<table border="0"> <tr> <td rowspan="4">TALBOT</td> <td>1610</td> <td>-</td> <td>1970...</td> </tr> <tr> <td>Chrysler 160,180,1610,2000</td> <td>-</td> <td>9/70-1981</td> </tr> <tr> <td>Matra Murena</td> <td>2200</td> <td>9/1980...</td> </tr> <tr> <td>Tagoro GL, GLS</td> <td>2200</td> <td>2/1981...</td> </tr> </table>	TALBOT	1610	-	1970...	Chrysler 160,180,1610,2000	-	9/70-1981	Matra Murena	2200	9/1980...	Tagoro GL, GLS	2200	2/1981...																						
	TALBOT	1610	-		1970...																																			
		Chrysler 160,180,1610,2000	-	9/70-1981																																				
Matra Murena		2200	9/1980...																																					
Tagoro GL, GLS		2200	2/1981...																																					
	4370*	113.127.025 - 211.127.025 APG PE 14925/1 - 15064	<table border="0"> <tr> <td>VOLKSWAGEN</td> <td>1200 (34 HP)</td> <td>8/60-8/65</td> <td></td> </tr> </table>	VOLKSWAGEN	1200 (34 HP)	8/60-8/65																																		
VOLKSWAGEN	1200 (34 HP)	8/60-8/65																																						
	4372	113127 025 A 113127 025 B 113127 025 C 113127 025 D 211127 025 A 311127 025 A 7.14963.50 7.15505.50 7.15506.50 7.15678.50 7.15679.50	<table border="0"> <tr> <td rowspan="9">VOLKSWAGEN</td> <td>1500</td> <td>(42/44 PS)</td> <td>8/64-10/70</td> </tr> <tr> <td>Type 1</td> <td>1200,1300,1500 (34/44 PS)</td> <td>8/60-7/73</td> </tr> <tr> <td>Type 1 1302 S, Ghia</td> <td>1600 (50 PS)</td> <td>8/70-7/73</td> </tr> <tr> <td>Type 122</td> <td>1200 (30 PS)</td> <td>3/1972...</td> </tr> <tr> <td>Type 124</td> <td>1500, 1600 (42/44 PS)</td> <td></td> </tr> <tr> <td>Type 126</td> <td>1500, 1600 (34/50 PS)</td> <td>5/1970...</td> </tr> <tr> <td>Type 181 Furgone</td> <td>1500, 1600 (44 PS)</td> <td>8/69-7/73</td> </tr> <tr> <td>Type 2</td> <td>1200 (24/30/34 PS)</td> <td>4/1950...</td> </tr> <tr> <td>Type 2</td> <td>1500, 1600 (42/44/50 PS)</td> <td>8/64-9/72</td> </tr> </table>	VOLKSWAGEN	1500	(42/44 PS)	8/64-10/70	Type 1	1200,1300,1500 (34/44 PS)	8/60-7/73	Type 1 1302 S, Ghia	1600 (50 PS)	8/70-7/73	Type 122	1200 (30 PS)	3/1972...	Type 124	1500, 1600 (42/44 PS)		Type 126	1500, 1600 (34/50 PS)	5/1970...	Type 181 Furgone	1500, 1600 (44 PS)	8/69-7/73	Type 2	1200 (24/30/34 PS)	4/1950...	Type 2	1500, 1600 (42/44/50 PS)	8/64-9/72									
VOLKSWAGEN	1500	(42/44 PS)	8/64-10/70																																					
	Type 1	1200,1300,1500 (34/44 PS)	8/60-7/73																																					
	Type 1 1302 S, Ghia	1600 (50 PS)	8/70-7/73																																					
	Type 122	1200 (30 PS)	3/1972...																																					
	Type 124	1500, 1600 (42/44 PS)																																						
	Type 126	1500, 1600 (34/50 PS)	5/1970...																																					
	Type 181 Furgone	1500, 1600 (44 PS)	8/69-7/73																																					
	Type 2	1200 (24/30/34 PS)	4/1950...																																					
	Type 2	1500, 1600 (42/44/50 PS)	8/64-9/72																																					







PUMP	PTZ number	original number	application
	4375	046127 025 7.20274.50 7.20998.51 9.06.802.11 BC-197 036.127.025 AGP PE 20160 046.127.025	AUDI 100 2000 (115 PS) 8/76-4/78 VOLKSWAGEN Golf 1100 5/74-4/78
	4376	036127 025 052 127 025 052127 025 B 052127 025 C 052 127 025 D 052 127 025 E 052127 025 F 052127 025 H 056127 025 E 056127 025 H 25061472 25066365 3509 461-78 5506970 7.15569.50 7.20135.50 7.20160.50 7.20372.50 7.20447.50 7.20664.50 7.20679.50 7.20805.50 7.20805.51 7.20845.51 8509 9.06.303.11 AB-599 BC-152 PL 3509 PDC 306	AUDI 50 1100,1300 (50/60 PS) 9/74-7/77 60 1500 (55 PS) 2/68-8/71 80 801 1300 (55 PS) 1/78-9/81 VOLKSWAGEN Derby 900,1100,1300 (40/60 PS) 3/77-9/81 Derby C, CL, GL 1050,1100,1300 (40/60 PS) 10/81-8/83 Golf 1100,1300 (50/60 PS) 5/74-9/81 Golf C, CL, GL 1100, 1300 (50/60 PS) 10/81-9/83 Jetta 1300 (60 PS) 9/79-9/81 Jetta C, CL, GL 1100,1300 (50/60 PS) 10/81-8/83 Passat 1300 801 1300 (55 PS) 3/78-9/81 Passat C, CL, GL 1300 (55 PS) 10/81-8/83 Polo 900,1100,1300(40/50/60PS) 3/75-9/81 Polo Coupe 801 1300 (55 PS) 9/1983... Polo Coupe GT 1300 (75 PS) 9/1982... Polo C, CL, GL 1050,1300 (40/60 PS) 10/81-8/83 Santana 1300 (FY-FZ) 1981-1984 Scirocco 1100,1300 (50/60 PS) 4/74-9/82
	4377	113127 025 E 113127 025 F 113127 025 G 7.20060.50 7.20170.50 7.20255.50 7.20804.51	VOLKSWAGEN Type 1 1200 (34 PS) 8/1973... Type 1 1303 1300 (44 PS) 1/1973... Type 1 1303 S 1200, 1600 (34/50 PS) 1/1973... Type 181 Furgone 1600 (44/48 PS) 8/1973... Type 2 1300 (40 PS) 9/1974... Type 2 1600 (50 PS) 1/73-4/79
	4377/1	025 127 025 070 127 025 7.20255.51 7.20804.50	VOLKSWAGEN Type 2 1600 (50 PS) 5/1979... Type 2 Syncro 1900 (60/78 PS) 9/1982...
	4378	AU 8/117	AUDI 100 mot. 1800







PUMP	PTZ number	original number	application
	4406*	23100.29116	TOYOTA Corolla TE 21 /27/28 74
	4407*	23100.49045-49046-49047-40050	TOYOTA Hi-Ace 5R 67-72 Stout 5R 67-72 Dyna 5R 67-72 Corona 1900 Exp.
	4408*	23100.36020 23100.39115-30116-39117-36011	TOYOTA Corona 16 R/18 R Hi-Lux 18 R 73-78 Celica RA23, 28, 40 1976-79 Hi-Ace RH22, RH32, RH42 1977-79 Hi-Lux RN41 1978-79
	4409	23100.39065-34040	TOYOTA Hi-Lux 6R - 8R 72-77 RN 22 72 MARK II 6R-8R/Corona 8R HI-ACE 6R/8R
	4410*	23100.29068-26023 23100.39067-29068-34042	TOYOTA Mark II 6R-8R 72 RX 12/22/28 Hi-Ace 6R-8R Hi-Lux 6R-8R-RN-RN22-RN27
	4411 *	23100.29057-29058-25013	TOYOTA Corolla T-2T 72-74 Carina T-2T 72-74 Celica 2T 72-74







PUMP	PTZ number	original number	application
	4412*	23100.29106	TOYOTA Corona TT 74 Celica TA 74
	4413*	23100.49015	TOYOTA CROWN R5 40-41-46
	4414*	23100.39125-34034-36050	TOYOTA Celica 16R - 18R 74-78 Corona 16R - 18R 74-78 Mark II 16R - 18R 74-78 Carina(RA)
	4415*	23100.39045-34020	TOYOTA Mark II 6R 69-72
	4416*	23100.39046-39047-34022	TOYOTA Mark II 6R 72-73
	4417*	23100.39058-34033	TOYOTA Celica 6R 72-74







PUMP	PTZ number	original number	application
	4418*	233100.29146	TOYOTA
	4419*	23100.29175-25014	TOYOTA Corolla T/2T 70-72 Carina T/2T 70-72 Celica 2T 70-72 Celica TA22, 23 2T 1970-76
	4420*	23100.29085-24030	TOYOTA Corolla 3K 73 Publica KP 30/31/36/37/45/47/40 Starlet 3K 73 Corolla KE10,11,16,17,18,20 K 1966-84 Corolla KE30,35,36,50 3KC 1974-78 Corolla KE38,55,70 4KC 1979-85 Lite Ace KM20 4KC 1980-85
	4421*	23100.29037-24011-29036	TOYOTA Corolla 3K 70-72 Publica 3K/Light Ace Kw10
	4422*	23100.29046	TOYOTA Corolla KE/KP Export 70-71
	4423*	23100.29038-24013	TOYOTA Corolla KE 20-25-26 3K - Publica 3K 72-74







PUMP	PTZ number	original number	application
	4424*	16700.634.305	HONDA (Vetture) Civic 1237 cc
	4425	732F-9350 AA AC 461-260 AC 7990217	FORD Capri 3000 03/73 - 81 Consul 2000 V4 - 2500 - 3000 03/73 - 75 Granada 2000 V4 - 2500 V6 - 3000 V6 03/73 - 77 Zodiac MK IV 10/71 - 72
	4426*	23100.39255-31050	TOYOTA Corolla 12 R 78 Hi-Lux 12 R
	4427*	23100.49125-49126-44021	TOYOTA Hi ACE RH 72-79 Stout RK 72-79 Dyna Through 72-79 Corona (RT)
	4428*	17010.H5326 - H6202	DATSUN - NISSAN 120 Y - A 14
	4429*	17010.B8229 - B8207 - B8288 - B8226 17010.B8206 - B8286 - B8208	DATSUN - NISSAN Pick-Up Truck 620 J15 75







PUMP	PTZ number	original number	application
	4430*	MD034060	mitsubishi Lancer 1400, tipo Galant, Polo, Colt
	4432	76 HF 9350 AA	FORD (GB) Velture Escort 1600 OHC - RS 2000 - Consul/Granada 2000
	4433*	23100.29205	TOYOTA U.S.A.
	4434*	23100.29235	TOYOTA U.S.A.
	4435	17010 - B9826 17010 - B9801	DATSUN - NISSAN 620 Pick-up (L20B Eng.) 82
	4436	17010 - B 9825	DATSUN - NISSAN 710 Sedan & Wagon - 2000 Eng. 77 - 82 620 Pick-up - 2000 Eng. 76 - 82







PUMP	PTZ number	original number	application		
	4437	17010 - N 5825/6 17010 - N 5800/1	DATSUN - NISSAN 510 Sedan & Wagon - 2000 Eng. 78 - 79 620 SX - L 20 B - 2000 Eng. 77 - 200B 1977-81 720 (2WD,4WD) L18 1980-85 Bluebird 1981-85		
	4439*	17010.H1903	DATSUN - NISSAN Nissan 1100/1200 Eng 70		
	4440	25061528 25066395 461-183 7971216	TRIUMPH GT 6 - 1968-1974 TR 5 - 1967-1968 TR 6 - 1969-1975 Vitesse 2000 1968-1971		
	4441	17010 - N0225/7 17010 - N0200	DATSUN - NISSAN Bluebird 521-Exp. (1400/1600 cc.-L14/L16 Eng.) 71-		
	4442	17010 - U0526 17010 - U6025/7 17010 - U6000/1	DATSUN - NISSAN Bluebird K 610 - Truck 620 72 - 75 (1600/200 cc. - L161L181L20 Eng. 1600 P510 1970-83 180B 1972-77 2300 1968-69 720 (2wd) 1979-80 Stanza A10 1978-83		
	4445	81 SF 9250 DB - 6.090.510	FORD (GB) Vetture Escort 1600 cc 80		







PUMP	PTZ number	original number	application
	4446	Chrysler 4131096 Carter M 600005	CHRYSLER Dodge Omni Plymouth Horizont (4 cil. - 1,7 Litre) - 78 - 78
	4447	4131.169	CHRYSLER
	4448	23100 - 19135/6 23100 - 13060	TOYOTA Corolla 30 (KE) (4K-C/1300 cc.) 80 - 82
	4449	23100 - 29245/6 23100 - 24080	TOYOTA Corolla (KE) 79 - Light-ace (NM) 79 - Publica (KP) (1200 cc. - 3KHS/3KC Eng.)
	4450	2724E-9350 E AC 461-223 AC 7971461	FORD Corsair V4 65 - 10/68 Zephyr 4-6 MK IV 66 - 08/69 Zodiac MK IV 66 - 09/69 2600 (4 cyl. Eng.) 66 -
	4451	2724E-9350 G AC 461-224 AC 7971462	FORD Corsair V4 10/68 - 70 Zephyr 4-6 MK 4 09/69 - 12/70 Zodiac MK 4 69 - 12/70







PUMP	PTZ number	original number	application
	4452	216559	TRIUMPH G16 2.0 1965 - 67 2000 OHV 1969 - 75 2500 TC OHV 1974 - 77
	4453	76 HF 9350 AA - 1562589	FORD Taunus 1600-2600
	4454*	17010.M2205/M2227	DATSUN - NISSAN Nissan FL 10/A14 120V, Sunny B210, B310 1974-79 Sunny A12, A14, A15 1978-85 Vanette C120 1980-84
	4455	16700.634.673	HONDA Civic (1237 cc.) 77 -
	4456	1450.44	PEUGEOT 504 Cabriolet mot. V6 10/74 604 (U.S.A.) 10/75
	4457*	23100.29026-22011	TOYOTA Corolla K/2 K





PUMP	PTZ number	original number	application
	4458*	23100 - 29215 23100 - 26100	TOYOTA Corolla (TE) (2T-Eng./1600 cc.) 78 - 79 Carina TA40 (2TC Eng.) 78 - 79
	4459	APG.PE 20014 - 15569 - 059.127.025 A/B	AUDI Audi 60/1500 2/68-7/72 Audi 70/1700 11/68-7/72 Audi 90/1800 12/55-8/71 Audi 100/1800-1900 12/68-7/76
	4460*	23100.69045-60061	TOYOTA Land Cruiser F 72-73
	4461	002 091 12 01 - APG PE 20215	DAIMLER - BENZ 230/4 U.S.A.
	4462*	17010.M6625	DATSUN - NISSAN Nissan
	4463	23100 - 61040	TOYOTA Land Cruiser (FJ) U.S.A. (4300 cc.-2F Eng.) 78 - 79







PUMP	PTZ number	original number	application
	4464	23100 - 61070	TOYOTA Land Cruiser (FJ) U.S.A. (4300 cc.-2F13F Eng.) 80...
	4465	23100 - 39335/6	TOYOTA 22R (2200 cc.) 80... (2200 cc. - 3A/C Eng.)
	4466	23100 - 39315	TOYOTA 22R (2200 cc.) 79 - 90 (2200 cc. - 22R Eng.)
	4467	M D026591	CHRYSLER K car U.S.A. (2600 cc. - 46S Eng.) 80...
	4468	23100 - 29225 23100 - 26110	TOYOTA Corolla (TE) (2T-C Eng.) 77 - 78
	4469*	17010.13901	DATSUN-NISSAN Nissan

PUMP	PTZ number	original number	application
	4470	17010 - W 8825/7 17010 - W 8800/2	DATSUN - NISSAN 510 Sedan & Wagon - 2000 Eng. 80...
	4471	4131.043	CHRYSLER
	4472	23100.61040 6.264202	TOYOTA (2 tubetti)
	4473	16700.734.005 16700.634.315 16700.634.0151	HONDA Civic (1237 cc.) 73... Civic EB1, EB2, EB3 1972-79
	4474	AP6 PE 20488 - 20450 - 20185	FORD Capri 2800 75-78
	4475	17010 - H 7200 17010 - H7202 17010 - H7225/7 17010 - H2787	DATSUN - NISSAN B 210 Sedan & Coups - 1400 Eng. 75 - 76 Sunny (1200/1500 cc. - A 12/14/15 Eng.) 76 - 81







PUMP	PTZ number	original number	application
	4476*	MD 005109	MITSUBISHI GALANT
	4477	MD 001047	MITSUBISHI GALANT
	4478*	9402.0460 - 9402.2939	ISUZU
	4479*	MD 023381	MITSUBISHI
	4480	23100 - 36060 23100 - 39245	TOYOTA Hi-ace (RH) (2000 cc. - 18 R Eng.) 75 -
	4481 *	MD 005100 - 005106	MITSUBISHI Galant GA, GB, GC, GD With Tank Return Lancer LC with tank return 1972-77 1979-81







PUMP	PTZ number	original number	application
	4482*	17010.H1925/H1926/H1906 H1900/4	DATSUN- NISSAN Nissan Sunny B10/A12 70-74 1200 B100 Ute A12 1971-85
	4483*	17010.12001/12202	DATSUN- NISSAN Nissan Fairlady R 16 65-67
	4484*	17010.25913	DATSUN- NISSAN Nissan Fairlady U20 67
	4485*	17010.H7229/H7262/H7263/H7285/ H7286	DATSUN- NISSAN Nissan
	4486*	17010.M2225/M2226/M2201	DATSUN- NISSAN Nissan Cherry A 12 74-78
	4487*	7950587	TRIUMPH GT6







PUMP	PTZ number	original number	application			
	4488	23100 - 31041 23100 - 39095 23100 - 39096	TOYOTA Corona (12R Eng.) 73 - 78 Hi-lux (12R Eng.) 73 - 80 Hi-Ace (RH) 73 - 78 Tojo-Ace (RV) 73 - 78 Hi-lux RN 30-40 (12 R Eng.) 78 - 84 Hi-Ace RH11,20,30 12R 1977-78 Hi-Lux RN20,30,40 12R 1971-83			
	4489*	23100.61011-61010	TOYOTA Land Cruiser 2F 75-76			
	4490*	23100.69055-60071	TOYOTA Land Cruiser F 70-72			
	4491	23100 - 61030	TOYOTA Land Cruiser FJ 40 - FJ 55 - 2F Eng. 77 - 79			
	4492	125 7784.2 125 7784 1261622.2 126 5192 132 5064.9 132 5235.9 1331 1257 784 1331 1261 622 1331 1265192 1331 1325 064 1331 1325 235 7.15560.50 7.15581.00 7.15585.00 7.20057.50 7.20217.50 7.20217.51 7.20498.51 7.20876. 51 8800 9.06.814.11 POC 509	BMW 1502 1600 (75 PS) 1/75-7/77 1602 1600 (85 PS) 8/73-7/75 1802 1800 (90 PS) 8/74-7/75 2002 2000 (100 PS) 10/73-7/75 2002 AT (USA) 2000 (100 PS) 4/1972... Marino 2000 (100 PS) 1/1968...			







PUMP	PTZ number	original number	application
	4493	127 2406 128 0956.2 128 0956 1331 1272 406 1331 1280 956 7.20397.50 7.20498.52 7.20807.50 8805	BMW 320, 320 AT 2000 6 cil. (122 PS) 9/1977... 520, 520 AT 2000 6 cil. (122 PS) 9/77-7/81
	4494*	23100.39016-31020	TOYOTA Corona 2R 65-72 Hi-Lux 2R 65-72 Hi-Ace 65-72
	4495*	23100.39085 - 31031	TOYOTA Hi-Lux 12 R 72-73
	4496	AC 461-126 AC 7950661 20852	TRIUMPH Courier (Eng. GA 13654-/Eng. GB1-GB2 2700-) 65 - 67 (dal mot. GA 13654 a dal mot. GB1-GB2 2700) Herald 1200 (-Eng. GA13654-/ 65 - 71 Eng. GB1-GB2 2700) Herald 12/50 - 13/60 65 - 71 Spitfire MK - II - III - IV - 74 1300 65 - 70
	4497*	MD 021328	MITSUBISHI Colt - Galant 72-78 Sigma GE, GH without tank return 1977-80
	4498*	MD 025290	MITSUBISHI Lancer 67-77

PUMP	PTZ number	original number	application
	4499*	17010.P5102/P5126/P5127/P5101	Nissan Truck H20 70-75
	4500	125 5306.2 7990400 1255 306 7.15615.50 1257 306 7.20498.50 1265 193 7.20876.50 1331 1255 8802 306 9.06.817.11 1331 1265 9.06.819.11 193 POC 5 10 25061582 461-280	BMW 316 1600,1800 (90 PS) 8/75-8/80 318, 318 AT 1800 (98 PS) 8/75-8/80 320 2000 4 cil. (109 PS) 8/75-8/77 518 1800 (90 PS), 2000 7/74-8/80 520, 520 AT 2000 4 cil. (115 PS) 9/72-8/77
	4501	126 3766.2 1331 1263 766 2402 7.20266.50 7.20810.50 9.06.815.11 POC 512	BMW 525, 525 AT 2500 (150 PS) 7/76-4/81 528, 528 AT 2500 (170 PS) 8/76-9/77 630 CS/AT 3000 (185 PS) 1/76-7/79 728, 728 AT (170 PS) 6/77-7/79 730, 730 AT 3000 (185 PS) 6/77-7/79
	4502	113945020	SKODA Estelle 1.0, 1.2, 1.3 OHV 1979 - 90 Skoda Favorit, Forman, Freeway 1.3 OHV 1989 - 93
	4503*	000 091 91 01 - 000 091 50 01 - 000 091 32 01 - APG PE 14918	DAIMLER - BENZ 70 SB (52 HP) 50-52 180 A (65 HP) 57-59 con leva di adescamento
	4506	C 30671	RELIANT Rialto-Fox-Robin







PUMP	PTZ number	original number	application			
	4507	816049 - PB 6960 - 5506960 8 160 23 8 160 25 8 160 34 8 160 50 7.15515.50 7.15612.50 7.20971.50 7.20971.56	OPEL Kadett D 1,3 - Ascona B 1,3 - Manta B 1,3 79-81 Admiral 1100 9/65-12/75 Ascona 1200 83 Ascona 1300 (mot. 348040) 79 Blitz 1,9 lt. 65-12/75 Kadett 1300 (mot. 348040) 79 Kadett, Olympia 1700 9/67-8/80 Kadett, Olympia 1500 9/67-8/70 Kapitän 1900 9/65-12/75 Manta 1300 N (mot. 348040) 79 Rekord 1500, 1700 65-2/71			
	4508	25061427 25061481 3440 3489001 3489002 461-358 461-80 461-86 5506967 7.20971.51 7.20971.55	OPEL Kadett D 1300 cc. 10/1981... Ascona C 1300 cc. 10/1981...			
	4509	08.55.809.600 08.55.970.100 461-61 5506973 77.01.017.595 77.01.349.383 PL 3000	FENWICK Carrelli elevatori RENAULT Alpine A 110 R 16 1966-1967 R16 L, TL, TA R1150 R1152, R1153 1968-6/72 OPEL Kadett D 1,3 1981... Ascona C 1,3 1981...			
	4510	25061466 25066412 3042 461-73 5506959 77.00.670.401 77.01.348.925 PV 3042	RENAULT R18 Diesel R1344 Mot.852 1982-1986 R20 Diesel TD, GTD R1276 12/1979...			
	4514	052.127.025 052.127.025. B 052.127.025. D 052.127.025. C 7.20135.50 7.20372.50 7.20447.50 7.20679.50 7.20845.51	VOLKSWAGEN Polo (900/1100/1300-40/50/60 HP) 03/75 - 09/81 Polo C-CL-GI (1000/1050/1300 cc. 40/50/60 H P) 10/81 - 08/83 Derby (900/1100/1300 cc.-40/50/60 HP) 03/77 - 09/81 Derby GCL-GI (1000/1100/1300 cc.-40/50/60 H P) 10/81 - 08/85 Jetta (1300 cc. - 60 HP) 09/79 - 09/81 Jetta GCL-GI (1100/1300 cc.-50/60 HP) 10/81 - 08/83 Golf (1100/1300 cc.-50/60 HP) 04/75 - 09/81 Golf C-CL-GI (1100/1300 cc.-50/60 HP) 10/81 - 08/83 Scirocco (1100/1300 cc.-50/60 HP) 04/74 Passat 1300 (Eng. 801 - 55 HP) 03/78 Passat C-CL-GI (1300 cc.-55 HP) 10/81 - 08/83			
	4515	AZX 1802	BRITISH LEYLAND Morris Marina 1700 - Ital 1700/2000 Sherpa serie OHC 78-80			





PUMP	PTZ number	original number	application
	4516	461.322	FORD Escort - Fiesta - Orion 1300/1600 80
	4517	8.160.57 AC 461-79 AC 5506966	OPEL Kadett D 1.1 - 1.2 Litre (Eng. 10/12-170259) 81 Corsa 10S (1000 cc.-45HP) 03/83 Kadett E 1.2S ONV 09/84 Ascona 13S 81-
	4518	8.160.56 AC 461-69 AC 5506960 7.20971.51 AC 461-80 AC 5506967	OPEL Kadett D 1.3 Litre (Eng. 13-348041) 81 - 83 Ascona C 1.3 N - 1.3S (1300 cc.-60/75HP) 10/81 Kadett E 1.2S ONV 09/82 Corsa 12S (1200 cc.-55HP) 03/83
	4519	750566 - 7.20806.50	SAAB 99 GL 2000 10/82-5/83
	4520	816059-5506975-461.85	OPEL Kadet D 1.6 - Ascona 1.6 - Mante 1.6 82 - GMN, Holden Camira JB, JD 1982-87
	4521	71802853	CHRYSLER-PAYKAN





PUMP	PTZ number	original number	application
	4522	750197 - 7.20806.51	SAAB 99 GL 2000 6/83
	4523	D4 RY 9350 A	FORD Capri U.S.A.
	4525	1450.58 - 25961432 - 461.89	PEUGEOT 305 GT (Mot. XU) 1 /83
	4526	76 TF 9K371 BA 74TF9350 BA 74TF9350 BB 75TF9350 AA 76TF9K371 AA 7.20428.54 - 6.031.493 - 6.012.683	FORD Capri 2800 (6/V) USA 2/74 Capri Arizona 2800 (6/V) USA 4/73-5/75 Mustang 2800 (6V) USA 4/73 Pinto 2800 (6V) USA 6/75
	4527	77.00.690.943 - 77.00.690.477 - 461.96	RENAULT R18 2,0 Export Gts, Tx, Gtx
	4529	AZX 1800	BRITISH LEYLAND Austin serie Marina Maestro 1600 L. HLS, MG. Maestro 3/83







PUMP	PTZ number	original number	application	
	4530	AZX 1811	BRITISH LEYLAND Austin Morris LM10 4E	
	4532	AZX 1814	BRITISH LEYLAND Austin LM11	
	4533	8.160.56 AC 461-69 AC 5506960 7.20971.51 AC 461-80 AC 5506967	OPEL Kadett D 1.3 Litre (Eng. 13-348041) Ascona C 1.3 N - 1.3S (1300 cc.-60/75HP) Kadett 12 ST (1200 cc.-55HP) Corsa 12S (1200 cc.-55HP)	81 - 83 10/81 09/82 03/83
	4535	23100 - 18010 23100 - 19105/6	TOYOTA Corolla (TE) Corona (TT) Carina (TA) Celica (TA) Mark II Chaser (TX) (1600/1800 cc. - 12 TN - 13 T/V Eng.)	79 - 83 79 - 83
	4536	10.4000.14 00.039.403.35 021.020.000	SEAT Ibiza (1.2 - 1.5 Porsche System) Ronda - Malaga (1.2-1.5)	
	4537	25061464 25066370 461-72 5506955 75510805 75521479 7.21757.50 8041 95496014 95585841 9.06.808.11 POC 514 PV 3041	CITROEN CX 20, 20 TRE CX 22 TRS CX Reflex, Athena CX TRS	- - 2000 2200 1982... 1986... 1971-8/82 -







PUMP	PTZ number	original number	application
	4541	D 27124 - 461.282 - 7990433	RELIANT Kitten
	4542	D 27123	RELIANT Robin
	4543	17010 - H 2502 17010 - H 2525	DATSUN - NISSAN 610 Sedan & Wagon - 1800 Eng. 72 - 73
	4545*	17010.H6203-17010.H6225- 17010.H6226	DATSUN - NISSAN 140 Y, Sunny (mot. A14) 140 J, Violet (mot. A14)
	4546*	17010-M0127-17010.M0128	DATSUN - NISSAN Cherry, E 10 - F 10 (mot. A10) '71/'73
	4547	918047	OPEL Monza 2,8 - Senator 2,8/3,0







PUMP	PTZ number	original number	application
	4548	8.160.62 7.20971.55 AC 461-86 3489001	OPEL Manta B 18S (1800 cc.-90 HP) 10/82 Rekord E 18N (1800 cc.-75 HP) 01/83 Rekord E 18S (1800 cc.-90 HP) 01/83 (Eng. D 1197760)
	4549	035.127.025	AUDI 100 (5 CYL.) 77
	4550	(uguale a 4427 ma con tubetti grandi)	TOYOTA Dyna
	4551	035.127.025G 7.20894.51 7.20811.53	AUDI Audi 80 LD (1900 cc. - 100/115 HP) 81 Audi 100-CC-CS-CD-Avant 01/83 (5 cyl.-1900 cc-100 HP) Audi Coupe GT5S (1900 cc.-115HP) 08/81
	4552	APG PE 20739 - 9312794	SAAB 900 2000 cc. mot. turbo (5/81)
	4553	002.091.79.01 002.091.66.01 002.091.56.01 7.20796.63 7.20796.53 7.20653.53	MERCEDES - BENZ 190/W 201/M102 (2000 cc.-90 H P) 01/83 190/W 201/M102 (2000 cc.-105 HP) 01/85 200/W 214/M102 (2000 cc.-109 HP) 01/85 200/W 123/M102 (2000 cc.-109 HP) 10/83







PUMP	PTZ number	original number	application
	4554	QFP 586	FORD Falcon
	4555	QFP 606	FORD Holden
	4556	AZX 1822	BRITISH LEYLAND Sherpa 1.7,2.0 Petrol OHC 1978-86
	4558	1475240 - 461.347	FORD Granada, Sierra 2.0 OHC 1984 on
	4559*	17010.H1026 - NP 403-1	DATSUN - NISSAN Nissan 120 Y, DL, SDX 1200 Eng. '75/'80







PUMP	PTZ number	original number	application
	4561	7971355 - 461.208	RELIANT Robin - Bong Bug Bvg
	4562	1450.57 1450.96 25061480 3219 461-355 7.21762.50 8219 8228 8229 91518057 91536319-80 93151495 95518057 96059584 BC-101 POC 637 PV 3219	CITROEN BX 15,16,19 RS, TRS XU5 1/84-1992 BX 19 GT XU 1905 7/84-7/85 XM 21 XU 1989-1992 PEUGEOT ZX 1580 1991-1993 205 XU5 1989-1992 305 GT 1905 1/1984... 305 GT Automat. XU 1600 1/84-7/85 305 GTX 1905 9/84-7/85 305 S, GT XU, XU5 2/1984... 309 GR, SR 1580 (XU51C),1900 9/1985... 405 1580(XU5-2C),1905(XU9-2C) 5/1987... 605 XU - 2.0 Ut. 1989-1992
	4563	PV 8736 PV 3736 77.00.733.545 77.00.723.168 25066369 25061430 3489005 461.95	RENAULT R 11 GTX-TXE 1700 03/83 - R19 GTX-TXE-TR-THE 1700 09/88 - R21 GTS-TS-TSE-Nevada 86 - R9 GTX-TXE 1700 03/84 - Supercinque GTR Spring B - Baccara 09/88 - Traffic T 1000B 09/88 -
	4564	23100 - 79025 23100 - 71020	TOYOTA Cressida Mark II (YH)-Hi-Lux (YH) 83 Hi-ace (YH)-Dyna (YU) (1660-2000 cc.-1Y12Y13Y) Toyota Dyna 200 YU60,62 3YC, 4YC 1984-91 Toyota Hi-Ace YH50 2YC 1983-84 Toyota Hi-Ace YH51 3YC 1984-86 Toyota Hi-Ace YH53,63,73 4YC 1986-89 Toyota Hi-Ace YH71 3Y 1983-86 Toyota Hi-Lux RN85,90,105 22R 1988-97 Toyota Hi-Lux YN57 3YC 1983-87 Toyota Hi-Lux 4 Runner YN60 3YC 1984-85 Toyota Hi-Lux 4 Runner YN63 4YC 1985-88 Toyota Hi-Lux YN55,56,57 1,2,3YC 1983-87 Toyota Hi-Lux YN58, YN67 4YC 1987-88 Toyota Hi-Lux YN85 2YC 1988-97 Toyota Tarago YR20 1YC 1983-84 Toyota Tarago YR21 3YC 1984-90 Daihatsu Delta V107, V108 4YC 1987-92 Daihatsu Delta V67, V68 3YC 1984-88 Daihatsu Rocky 4x4 F80,F85,F87 3YC 1984-89
	4565	23100 - 79015 23100 - 71010	TOYOTA-DAIHATSU Light-ace (YM) - Town-ace (YR) 83 Master-ace (YR) (1600-1800 cc.-1Y/2Y Eng.) Toyota Lite Ace KM36 5KC 1986-92 Toyota Lite Ace YM21,YM30,YM35 2YC 1984-92 Toyota Lite Ace YM40,41 3YC 1986-88 Toyota Tarago YR20,21 2YC, 3YC 1983-90 Townace YR39RV 3YC 1992 on







PUMP	PTZ number	original number	application			
	4566	PV 8738 7000048	RENAULT VOLVO	R 21 1721 L.L. 360 GLE 1700	1986... 1982...	
	4567	3342128.0	VOLVO	340 (B 172 Eng.) 440 460	1985 1988-1991 1989-1991	
	4568	AZX 1823	BRITISH LEYLAND	Austin Rover Montego 2,0 litri		
	4570	2108.1106010 2108.910610 8521	LADA	Carlota Samara	1100,1300,1500 1100,1300,1500	- 1987-1992
	4571	052 127 025J 7.20916.51 7.20916.52 7.21500.50	VOLKSWAGEN	Derby C-CL-GL, 1300 mot. 801 (55ps) 9/83 Golf C-CL-GL, 1300 mot. 801 (55ps) 9/83-7/85 Jetta C-CL-GL 1300 mot. 801 (55ps) 9/83-7/85 Passat C-CL-GL, 1300 mot. 801 9/83 Polo C-CL-GL, 1300 mot. 801 (55ps) 9/83-6/85 Polo Coupe GT mot. 801 (55ps) 9/83 Santana C-CL-GL, 1300 (55ps) 9/83 Scirocco 1100-1300 (50-60ps) 8/82		
	4572	127 6550.2 1274 742 1274 742.2 1276 550 1331 1274 742 1331 1276 550 7.20756.50 7.20785.50 7.20808.50 7.20809.50	BMW	315 316 518, 518 AT	1600 1600,1800 (90 PS) 1800 (98 PS)	1980-1983 9/80-6/83 8/80-6/83







PUMP	PTZ number	original number	application			
	4573	P-650 E3 - Y1 - 13350	FORD (USA) MAZDA	Laser KA - KB 1300-1500 Mateor GA - GB 1500 Laser KC, KE E3 323 E3	2/81-9/85 2/81-9/85 1985-87 1980-85	
	4575	1450.66 91536319 1450.74 91539545 P 1450.80 PV 7.211450.66 8227 1450.74 1450.80 - 7.21765.50 8227 91518057	CITROEN PEUGEOT	BX 15,16,19 BX 19 SPORT 205 205 305 GT, GTX 309 309 405 GL, GR, SR	XU5 XU9 XU XU 1600 XU 1600,1900 (XU) XU 1900 1600,1900 (XU)	7/85-9/89 1985-1989 7/90-4/92 7/87-6/90 7/1985... 11/1985... -
	4577	AC 461-395 7.20971.63	OPEL	Corsa 1200 S/ST-1300 ND/S/SB Kadett 1200 S OHC Kadett 1300 N/NB/S Kadett 1600 S/SU Vectra 1400 - 1600	09/88... 09/88... 09/88... 09/88... 88	
	4578	23100 - 26031 23100 - 29096	TOYOTA	Celica TA40 (2T-G Eng.) Carina (2T-G Eng.) Celica (2T-G Eng.) Corolla TE 47 (2T-G Eng.) Corolla TE 71 E (2T-G Eng.)	77 - 74 - 74 74 - 79 79 - 83	
	4579	6488775	FORD	Escort 1.3 OHV Fiesta 1.0 OHV Fiesta 1.1 OHV manual Fiesta 1.3 OHV Orion 1.3 OHV Courier Van 1.1, 1.3 OHV Fiesta Van 1.3 OHV Fiesta Van 1.0, 1.1, 1.3 OHV		
	4580	16700PE00237013	HONDA	Civic 1,2 - 1,3 - 1,5 Excl.Inj.Series AL,AM,AG,AS,AR,AK to ch.No 1008519-Shuttle 2 Wd (to Ch.1006989) Civic 1500 EC	84- 1984-87	







PUMP	PTZ number	original number	application		
	4581	AC 461-361 87SF-9350-AA	FORD	Escort 1400-1600 CVH Fiesta 1400-1600 CVH Orion 1400-1600 CVH Escort MkV 1.1, 1.3 OHV	03/87-- 03/87-- 03/87--
	4582	128 7333.2 128 7333 1331 1287 333 7.20807.51 8804	BMW	316 518 + AT 1600,1800 (90 PS) 1800 (98 PS)	7/1983... 7/1983...
	4583	AC 461-395 7.20971.63	OPEL	Corsa 1200 S/ST-1300 ND/S/SB Kadett 1200 S OHC Kadett 1300 N/NB/S Kadett 1600 S/SU Vectra 1400 - 1600	09/88... 09/88... 09/88... 09/88... 88
	4584	6551959	FORD	Escort 1.4 CVH Escort 1.6 CVH Fiesta 1.4 CVH Fiesta 1.6 CVH Orion 1.4 CVH Orion 1.6 CVH Escort Van 1.4 CVH Escort Van 1.6 CVH	9/90-10/92 8/90-10/92 8/90-10/92 8/90-10/92 8/90-10/92 8/90-10/92 8/90-10/92 8/90-10/92
	4585	035.127.025D 7.20627.53 720801.51	AUDI	100-C-CL-CS-GL-AVANT	
	4586	3049 77.00.749.253 77.00.743.727 77.00.851.879 77.00.853.480 77.00.860.573 8728 8729 8739	RENAULT	Chamade RT, GTX, TXE Clio RT Fuego TX, GTX, Automatica Nevada Break/Estate R18 Export GTS R18 ExportTX, GTX R19 GTX, TXE R19, R21 (Vett.extra europees) R21 Nevada TS, GTS R21 TS, GTS, RS	L533 E2N 1700 2100 F2N 2100 2100 1700 F2N 1700-B53M, C53M 1700 - 1,7 F2N-711/720/721/754 1989-1993 7/1990... 1980... 1986-1992 1980... 1980... 9/1988... - - 7/1991...







PUMP	PTZ number	original number	application
	4587	17010 - 23M25	DATSUN Cherry 1.3 (N12) (E13 Eng.) OHC Cherry 1.5 (N12) (E15 Eng.) OHC Sunny 1.3 (B11,N13) (E13S Eng.) OHC 10/82-85 2/84-89
	4588	17010 - R7400	NISSAN Cherry Europe 1.2, 1.5 (920) 83-85
	4589	O.E.035.127.025C 7.20811.51 7.20894.50	AUDI Coupe GT 5S 10/80 - 07/81 VOLKSWAGEN Passat CL15 - GL15 1900cc - 100
	4590	17010 - 01M26	DATSUN Cherry 1.0 (N12) (E10 Eng.) OHC Cherry 1.3 (N12) (E13 Eng.) OHC Cherry 1.5 (N12) (E15 Eng.) OHC Prairie 1.5 (M10) (E15 Eng.) OHC Sunny 1.3 (B11) (E13S Eng.) OHC Sunny 1.5 (B11) (E15S Eng.) OHC Sunny Van 1.3 (B11) (E13S Eng.) OHC 4/82 - 10/82 4/82 - 10/82 4/82 - 10/82 19/83 - 5/85 3/82 - 2/83 3/82 - 2/83 3/82 - 2/83
	4591	17010 - 34A25	DATSUN Cherry 1.0 (N12) (E10 Eng.) OHC Cherry 1.3 (N12) (E13 Eng.) OHC Cherry 1.5 (N12) (E15 Eng.) OHC Prairie 1.5 (M10) (E15 Eng.) OHC Sunny 1.3 (B11,N13) (E13 Eng.) OHC Sunny 1.5 (B11) (E15 Eng.) OHC Sunny Van 1.3 (B11,N13) (E13S Eng.) OHC GMH, Holden Holden Astra LB, LC Hatch E15, E16S NISSAN Nissan Prairie M10 E15 Nissan Pulsar N10, N12 E13, E15 Nissan Vanette C120 A15 1985 - 12/86 1985 - 12/86 1985 - 12/86 5/85 - 87 2/84 - 89 2/84 - 86 2/84 - 89 1984-87 1982-86 1981-86 1982-86
	4592	17010 - 01B27	DATSUN Cherry 1.0 (N12) (E10 Eng.) OHC Micra 1.0 (K10) (MA10 Eng.) OHC 10/82 - 85 10/83 - 85







PUMP	PTZ number	original number	application			
	4593	1450.73 1450.86 7.21764.50 8223 PL 3223	PEUGEOT	504 PU (CHINA) 505	XNA, XMA XN1A-XM7A-GL,GR,SR	1991... 7/1985...
	4594		SUZUKI - MARUTI			
	4595	WND10004	ROVER	214 S Carb.Eng Metro 1.1, 1.4 8V Carb.Eng.		90-92
	4597	15000-883000 15100-82010 15100-82610 15100-A83000 8851	SUZUKI-SANTANA	tultus SJ 413, Samurai Swift	1325 cc. 1325 cc. 1325 cc.	9/1984... 9/1984... 9/1984...
	4598	17010 - 36A25	NISSAN	Sunny 1.6 (B12,N13) (E16 Eng.) OHC		1986-88
	4599	15100 - 78140	SUZUKI	Alto (eng.SS80/F8A - SB308/F8A) Alto		1981...







PUMP	PTZ number	original number	application																															
	4600	030127 025 7.20884.53 8508 POC 680	<table border="0"> <tr> <td>BARKAS</td> <td>Barkas 100</td> <td>1300cc-VAG</td> <td>...1991</td> </tr> <tr> <td>TRABANT</td> <td>Trabant</td> <td>1100 VAG Type 111</td> <td>1989...</td> </tr> <tr> <td rowspan="6">VOLKSWAGEN</td> <td>Derby C, CL, GL</td> <td>111 1300 (55 PS)</td> <td>8/1985...</td> </tr> <tr> <td>Golf C, CL, GL</td> <td>111 1300 (55 PS)</td> <td>8/1985...</td> </tr> <tr> <td>Jetta C, CL, GL</td> <td>111 1300 (55 PS)</td> <td>8/1985...</td> </tr> <tr> <td>Polo Coupe</td> <td>111 1300 (55 PS)</td> <td>8/1985...</td> </tr> <tr> <td>Polo C, CL, Fox</td> <td>111 1050 (45 PS)</td> <td>7/1985...</td> </tr> <tr> <td>Scirocco Type 53</td> <td>1300cc</td> <td>1983-1987</td> </tr> <tr> <td>WARTBURG</td> <td>Wartburg 4 Takter</td> <td>1300 -111 VAG</td> <td>1989...</td> </tr> </table>	BARKAS	Barkas 100	1300cc-VAG	...1991	TRABANT	Trabant	1100 VAG Type 111	1989...	VOLKSWAGEN	Derby C, CL, GL	111 1300 (55 PS)	8/1985...	Golf C, CL, GL	111 1300 (55 PS)	8/1985...	Jetta C, CL, GL	111 1300 (55 PS)	8/1985...	Polo Coupe	111 1300 (55 PS)	8/1985...	Polo C, CL, Fox	111 1050 (45 PS)	7/1985...	Scirocco Type 53	1300cc	1983-1987	WARTBURG	Wartburg 4 Takter	1300 -111 VAG	1989...
BARKAS	Barkas 100	1300cc-VAG	...1991																															
TRABANT	Trabant	1100 VAG Type 111	1989...																															
VOLKSWAGEN	Derby C, CL, GL	111 1300 (55 PS)	8/1985...																															
	Golf C, CL, GL	111 1300 (55 PS)	8/1985...																															
	Jetta C, CL, GL	111 1300 (55 PS)	8/1985...																															
	Polo Coupe	111 1300 (55 PS)	8/1985...																															
	Polo C, CL, Fox	111 1050 (45 PS)	7/1985...																															
	Scirocco Type 53	1300cc	1983-1987																															
WARTBURG	Wartburg 4 Takter	1300 -111 VAG	1989...																															
	4602	8.160.70 7.20971.59 8.160.068	<table border="0"> <tr> <td rowspan="8">VAUXHALL</td> <td>Kadett E 1800 NV AGR + AT</td> <td>2/1987-7/89</td> </tr> <tr> <td>Kadett S + AT (Africa)</td> <td>8/1986...</td> </tr> <tr> <td>Kadett S 1800 NV + AT (CH/S)</td> <td>6/1986-10/87</td> </tr> <tr> <td>Ascona C/E 1800 NVR + AT</td> <td>2/1987-12/88</td> </tr> <tr> <td>Vectra E 1800 NV + AT</td> <td>1/1989...</td> </tr> <tr> <td>Vectra 1800 S GL + NV + AT</td> <td>10/1988...</td> </tr> <tr> <td>Omega E + EC 1800 NV/SV + AT</td> <td>6/1986...</td> </tr> <tr> <td>Omega 1800 NV (CH/S)</td> <td>6/1986-8/86</td> </tr> </table>	VAUXHALL	Kadett E 1800 NV AGR + AT	2/1987-7/89	Kadett S + AT (Africa)	8/1986...	Kadett S 1800 NV + AT (CH/S)	6/1986-10/87	Ascona C/E 1800 NVR + AT	2/1987-12/88	Vectra E 1800 NV + AT	1/1989...	Vectra 1800 S GL + NV + AT	10/1988...	Omega E + EC 1800 NV/SV + AT	6/1986...	Omega 1800 NV (CH/S)	6/1986-8/86														
VAUXHALL	Kadett E 1800 NV AGR + AT	2/1987-7/89																																
	Kadett S + AT (Africa)	8/1986...																																
	Kadett S 1800 NV + AT (CH/S)	6/1986-10/87																																
	Ascona C/E 1800 NVR + AT	2/1987-12/88																																
	Vectra E 1800 NV + AT	1/1989...																																
	Vectra 1800 S GL + NV + AT	10/1988...																																
	Omega E + EC 1800 NV/SV + AT	6/1986...																																
	Omega 1800 NV (CH/S)	6/1986-8/86																																
	4603	15100-80000-32 M	<table border="0"> <tr> <td>SUZUKI</td> <td>SJ 410-SJ 410V-SS 410K-SS410W</td> <td>81-</td> </tr> </table>	SUZUKI	SJ 410-SJ 410V-SS 410K-SS410W	81-																												
SUZUKI	SJ 410-SJ 410V-SS 410K-SS410W	81-																																
	4604	I 17010-Y0126/7	<table border="0"> <tr> <td>DATSUN</td> <td>Skyline T 230 - K 230</td> <td>73 -</td> </tr> </table>	DATSUN	Skyline T 230 - K 230	73 -																												
DATSUN	Skyline T 230 - K 230	73 -																																
	4606	F881-13-350	<table border="0"> <tr> <td>MAZDA</td> <td>626 Ekp.Capella-Telstar (1800/2000 cc)</td> <td>87-</td> </tr> <tr> <td></td> <td>626 GC 1983-87</td> <td></td> </tr> <tr> <td>FORD</td> <td>Telstar AR, AS, AT, AV</td> <td>1983-89</td> </tr> </table>	MAZDA	626 Ekp.Capella-Telstar (1800/2000 cc)	87-		626 GC 1983-87		FORD	Telstar AR, AS, AT, AV	1983-89																						
MAZDA	626 Ekp.Capella-Telstar (1800/2000 cc)	87-																																
	626 GC 1983-87																																	
FORD	Telstar AR, AS, AT, AV	1983-89																																
	4607	F80113350B	<table border="0"> <tr> <td rowspan="3">MAZDA</td> <td>626 1.6 (GC1)</td> <td></td> </tr> <tr> <td>626 1.8 (GD1)</td> <td></td> </tr> <tr> <td>626 2.0 (Carb)(GC 1)</td> <td></td> </tr> <tr> <td></td> <td>323 E3,E5</td> <td>1980-85</td> </tr> <tr> <td>FORD</td> <td>Laser KA, KB</td> <td>1981-85</td> </tr> </table>	MAZDA	626 1.6 (GC1)		626 1.8 (GD1)		626 2.0 (Carb)(GC 1)			323 E3,E5	1980-85	FORD	Laser KA, KB	1981-85																		
MAZDA	626 1.6 (GC1)																																	
	626 1.8 (GD1)																																	
	626 2.0 (Carb)(GC 1)																																	
	323 E3,E5	1980-85																																
FORD	Laser KA, KB	1981-85																																





PUMP	PTZ number	original number	application
	4608	23100 - 79025 23100 - 71020	TOYOTA Cressida Mark II-HI-LUX-HI-AGE-Dyna 83-
	4611	15100A7880-000	DAEWU Tico
	4612		FORD Cargo Dover Diesel
	4614		Moskvitch
	4615	23100 - 15080/1	TOYOTA Corolla 1.6 (AE 92) 87-93 Corolla AE90, 92 4AFC, 6AFC 1989-94
	4617	2310034286	TOYOTA Hi Lux 2.0 4WD (RV36,46) (16R Eng.) 1979 - 83

PUMP	PTZ number	original number	application
	4618	145096	CITROEN BX 16 OHC 9/89-12/91 BX 19 OHC 9/89-12/91 XM 2.0 OHC 1989-12/91
	4620	145502	CITROEN BX 16 OHC 1/92-12/93 BX 19 OHC 1/92-6/94 XM 2.0 OHC 12/91-92
	4621	2310079027	TOYOTA Hi Lux 1.8 (YN56R) (2Y Eng.) 1983-88 Hi Lux 2.0 4WD (YN56) (3Y Eng.) 1983-86
	4622	2310013111	TOYOTA Lite Ace 1.5 (KM36) (5K Eng.) 1988-92
	4624	2310011080	TOYOTA Corolla 1.6 (EE90) (2E Eng.) 1989-92
	4625	2310013091	DAIHATSU Charmant 1.3 OHV 1982-86

PUMP	PTZ number	original number	application		
	4628	7636595	FIAT	Cinquecento 700	5/1992...
	4629	7579696	FIAT	Croma 1,6	1,6
	4700	6174810	FORD	(HCS) 3 tubes Fiesta MK IV, V 1.1, 1.3 OHV Orion 1.3 OHV	08/89-08/90 8/88-8/90
	4703		KIA PAYKAN FORD MAZDA	Festiva WA B3 1.3 323 BF, B6 1.6	Pride 1991-94 1985-89
	4703/1	150-13-350B	KIA	Pride	
	4704	MD 997694	MITSUBISHI HYUNDAI	Colt 1200 (A151 - G11 B engine) Colt 1400 (A152 - G12B engine) Lancer 1200 (A171 - G11 B engine) Galant 2000 (E15 - 6638 engine) Pony 1200 Pony 1200 Pick-Up	8/81 - 10/83 8181 - 10/82 9179 - 1/83 8/83 - 1/86 79-85 82-91



PUMP	PTZ number	original number	application
	4705	31700-21003	HYUNDAI Pony 1300 (G13B engine) 10/85 ... 1/87 Pony 1300 LS (G13B engine) 10/92 ... 1/93 Pony 1500/172 (G15B engine) 10/85 ... MITSUBISHI Colt 1.3 (4G13-C51 Eng) 4/88 ... 5/99 Colt 1.5 (4G15-C52 Eng) 4/88 ... 5/99 Galant 2.0 (E15A) (4G63 Eng) 6/86 ... 2/93 Lancer 1.5 (SNC12A) (4G15 Eng) 1984 ... 1990 Spacewagon 2.0 (D08W) 6/87 ... 9/90
	4706		MITSUBISHI Colt RA 4G12 1.4 1981-82
	4722		TOYOTA 2F Landcruiser FJ40, 45 1977-78 2F Landcruiser FJ60 1980-84
	4724		TOYOTA Celica RA40 18R-C 1979-80 Corona RT132 18RC 1980-81 Hi-Ace RH22, RH32, RH42 18RC 1979-83 Hi-Lux RN41, RN46 18R 1979-83
	4726		NISSAN Cabstar VH40 Z22 1982-87 Navara Z20, Z24 1986-97 Nomad C22 Z24 1987-88 Pathfinder Wagon WD21 Z24 1986-92 Urvan E23, E24 1982-93 Vanette C22 Z20 1987-93
	4727		GMH, HOLDEN Gemini TE, TF, TG G161Z 1979-85 Rodeo KB, KB21, 27, 28 1983-87



PUMP	PTZ number	original number	application
	4730		FORD Ford Courier UA, UE, UF FE, F2 1985-89 Ford Econovan & Maxi F8, FE 1984-97 Ford Econovan FE 1997 Ford Spectron F8, FE 1984-97 MAZDA Mazda B2000 FE 1982-89 Mazda B2200 F2 1988-93 Mazda E1800 F8 1990-96 Mazda E2000 (inc 4x4) FE 1984-90
	4738		SUZUKI Carry Van ST90V F8A 1979-85
	4739		GM, HOLDEN Drover QB G13A 1985-87
	4740		SUZUKI Sierra 4x4 SJ410 F10A 1981-88 Swift SF310 G10A 1989-91 Swift SF413 (SOHC) G13B 1990-95
	4746		NISSAN Patrol 60 Series P40 1965-80
	4747		TOYOTA T-18 TE72 3T-C 1979-83



PUMP	PTZ number	original number	application		
	4748		TOYOTA	Landcruiser FJ40,55 F Landcruiser FJ40,45 2F	1970-80 1975-77
	4749		TOYOTA	Landcruiser FJ62,70,73,75 3F	1985-87
	4751		FORD MAZDA	Ford Laser KF, KH B6 Mazda 323 B6 B6	1990-94 1989-94
	5000	25068451 461-354 7537698 7564923 7581031 7581032 7797698 7.21773.50 8604	AUTOBIANCHI FIAT	Y 10 4WD-FL89 Panda Panda 1000 Super,4x4, Siskey Tipo, Tipo DGT Uno Uno R89	Fire 1000 Fire 750, 1000 1000 1100 Fire 1000 Fire 1000,1100
	5001	7660776	FIAT	Cinquecento 900 Carburatore	5/1992...







diesel

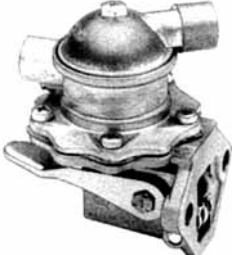

fuel pumps for vehicles

PUMP	PTZ number	original number	application
	6000	Axerio 100.9443 Carraro 30424	AXERIO Motocompressori A 55 - A 75 Motocompressori A 103 - A 103 B CARRARO: Motocompressori A 103 C - D 32 - dal 1971 Trattori con motore 300
	6001	Lombardini 276.6585.11	CARRARO - Trattori Supertigre 635 con mot. LDA 672 Supertigre 650 con mot. LDA 673 Supertigre 835 con mot. LDA 672 Tigrone 850 con mot. LDA 672 Tigrone 750 - Atlas 750 Tigrone Tropical 750/765 Tigrone Atlas 765 FERRARI MC 60 RT con mot. LDA 672 MT 65/30-35 MT 75 con mot. LDA 672 MT 65/30-35 MT 76 con mot. LDA 673 GOLDONI Trattore GM4 - L 30 Trattore Universal 230 con mot. LDA 672 LOMBARDINI LDA 672 - 673 - 832 - 833 Trattori: Bertolini 430 con mot. LDA 672 Bertolini 432 con mot. LDA 672 Bertolini 440/3 C con mot. LDA 673 Bertolini 450/3 C con mot. LDA 673 TOSELLI Trattore Euro 30 - Record con mot. Lombardini LDA 672
	6002	4631972 4718363	FIAT Trattori a benzina mot. 8035.42.005 per applicazioni «UNIC France».





PUMP	PTZ number	original number	application																																																																																																
	6003	115.16.070 4609596 4648022 4660069 4667509 4709282 4740717 4756678 4757883 9.06.032.11 9.06.161.1 1 POC 098 PON 108	<table border="0"> <tr> <td>AIFO</td> <td>Industriale</td> <td>8041.25.200</td> </tr> <tr> <td>FIAT/HITACHI</td> <td>AD4, FL4, FL4/C, FL4/D</td> <td>-</td> </tr> <tr> <td></td> <td>Idroverti TLS, TLSH, 560</td> <td>-</td> </tr> <tr> <td>FIAT-OM CARRELLI ELEVATORI</td> <td>DI12, DI15, DI20, DI25</td> <td>3 Cil.</td> </tr> <tr> <td></td> <td>DI20C, DI25C, DI30C</td> <td>3 Cil.</td> </tr> <tr> <td></td> <td>DI30CH, DI135C, DI40C, DI50</td> <td>4 Cil.</td> </tr> <tr> <td></td> <td>DI130, DI35, DI40</td> <td>4 Cil.</td> </tr> <tr> <td>IVECO</td> <td>Industriale</td> <td>D.8031.05.300</td> </tr> <tr> <td></td> <td>Industriale</td> <td>D.8035.05.200</td> </tr> <tr> <td></td> <td>Industriale</td> <td>D.8035.05.208/265/308/359</td> </tr> <tr> <td></td> <td>Industriale</td> <td>D.8035.06.240/309/340</td> </tr> <tr> <td></td> <td>Industriale</td> <td>D.8035.06.342/343</td> </tr> <tr> <td></td> <td>Industriale</td> <td>D.8041.05.200/206/306</td> </tr> <tr> <td></td> <td>Industriale</td> <td>D.8045.05.200</td> </tr> <tr> <td></td> <td>Industriale</td> <td>D.8045.05.200/201 /204</td> </tr> <tr> <td></td> <td>Industriale</td> <td>D.8045.05.206/207/209</td> </tr> <tr> <td></td> <td>Industriale</td> <td>D.8045.05.307/359/370/389</td> </tr> <tr> <td></td> <td>Industriale</td> <td>D.8045.06.206/320/322/346</td> </tr> <tr> <td></td> <td>Industriale</td> <td>D.8045.25.305/370/375</td> </tr> <tr> <td>NEW HOLUIND (FIAT GEOTECH)</td> <td>Trattore</td> <td>8045.06.200</td> </tr> <tr> <td></td> <td>Tr. 350, 355, 400</td> <td>-</td> </tr> <tr> <td></td> <td>Tr. 420, 450, 450DT</td> <td>-</td> </tr> <tr> <td></td> <td>Tr. 455</td> <td>-</td> </tr> <tr> <td></td> <td>Tr. 455C, 470, 480DT</td> <td>-</td> </tr> <tr> <td></td> <td>Tr. 500, 500DT, 505</td> <td>-</td> </tr> <tr> <td></td> <td>Tr. 505C, 500DT Special</td> <td>-</td> </tr> <tr> <td></td> <td>Tr. 540, 550, 550DT</td> <td>-</td> </tr> <tr> <td></td> <td>Tr. 555, 580, 600DT</td> <td>-</td> </tr> <tr> <td></td> <td>Tr. 600DT3, 605</td> <td>-</td> </tr> <tr> <td></td> <td>Tr. 605C, 640, 640DT</td> <td>-</td> </tr> <tr> <td>TRACTORUL BRASOV</td> <td>Trattore</td> <td>1500</td> </tr> <tr> <td>UNIVERZAL</td> <td>Tr. 445/550</td> <td>-</td> </tr> </table>	AIFO	Industriale	8041.25.200	FIAT/HITACHI	AD4, FL4, FL4/C, FL4/D	-		Idroverti TLS, TLSH, 560	-	FIAT-OM CARRELLI ELEVATORI	DI12, DI15, DI20, DI25	3 Cil.		DI20C, DI25C, DI30C	3 Cil.		DI30CH, DI135C, DI40C, DI50	4 Cil.		DI130, DI35, DI40	4 Cil.	IVECO	Industriale	D.8031.05.300		Industriale	D.8035.05.200		Industriale	D.8035.05.208/265/308/359		Industriale	D.8035.06.240/309/340		Industriale	D.8035.06.342/343		Industriale	D.8041.05.200/206/306		Industriale	D.8045.05.200		Industriale	D.8045.05.200/201 /204		Industriale	D.8045.05.206/207/209		Industriale	D.8045.05.307/359/370/389		Industriale	D.8045.06.206/320/322/346		Industriale	D.8045.25.305/370/375	NEW HOLUIND (FIAT GEOTECH)	Trattore	8045.06.200		Tr. 350, 355, 400	-		Tr. 420, 450, 450DT	-		Tr. 455	-		Tr. 455C, 470, 480DT	-		Tr. 500, 500DT, 505	-		Tr. 505C, 500DT Special	-		Tr. 540, 550, 550DT	-		Tr. 555, 580, 600DT	-		Tr. 600DT3, 605	-		Tr. 605C, 640, 640DT	-	TRACTORUL BRASOV	Trattore	1500	UNIVERZAL	Tr. 445/550	-
AIFO	Industriale	8041.25.200																																																																																																	
FIAT/HITACHI	AD4, FL4, FL4/C, FL4/D	-																																																																																																	
	Idroverti TLS, TLSH, 560	-																																																																																																	
FIAT-OM CARRELLI ELEVATORI	DI12, DI15, DI20, DI25	3 Cil.																																																																																																	
	DI20C, DI25C, DI30C	3 Cil.																																																																																																	
	DI30CH, DI135C, DI40C, DI50	4 Cil.																																																																																																	
	DI130, DI35, DI40	4 Cil.																																																																																																	
IVECO	Industriale	D.8031.05.300																																																																																																	
	Industriale	D.8035.05.200																																																																																																	
	Industriale	D.8035.05.208/265/308/359																																																																																																	
	Industriale	D.8035.06.240/309/340																																																																																																	
	Industriale	D.8035.06.342/343																																																																																																	
	Industriale	D.8041.05.200/206/306																																																																																																	
	Industriale	D.8045.05.200																																																																																																	
	Industriale	D.8045.05.200/201 /204																																																																																																	
	Industriale	D.8045.05.206/207/209																																																																																																	
	Industriale	D.8045.05.307/359/370/389																																																																																																	
	Industriale	D.8045.06.206/320/322/346																																																																																																	
	Industriale	D.8045.25.305/370/375																																																																																																	
NEW HOLUIND (FIAT GEOTECH)	Trattore	8045.06.200																																																																																																	
	Tr. 350, 355, 400	-																																																																																																	
	Tr. 420, 450, 450DT	-																																																																																																	
	Tr. 455	-																																																																																																	
	Tr. 455C, 470, 480DT	-																																																																																																	
	Tr. 500, 500DT, 505	-																																																																																																	
	Tr. 505C, 500DT Special	-																																																																																																	
	Tr. 540, 550, 550DT	-																																																																																																	
	Tr. 555, 580, 600DT	-																																																																																																	
	Tr. 600DT3, 605	-																																																																																																	
	Tr. 605C, 640, 640DT	-																																																																																																	
TRACTORUL BRASOV	Trattore	1500																																																																																																	
UNIVERZAL	Tr. 445/550	-																																																																																																	
	6004	4660068 4667510 4709283 4740718 4757882 60268	<table border="0"> <tr> <td>FIAT-HITACHI</td> <td>Pala mec.FL4/D, FL4/L, FL4/C</td> <td>8035.01.265</td> </tr> <tr> <td>FIAT-OM CARRELLI ELEVATORI</td> <td>DIM20, DIM25</td> <td>3 Cil.</td> </tr> <tr> <td></td> <td>DIM30, DIM35</td> <td>4 Cil.</td> </tr> <tr> <td></td> <td>DM12, DM15</td> <td>3 Cil.</td> </tr> <tr> <td>STORE</td> <td>402/404</td> <td>-</td> </tr> </table>	FIAT-HITACHI	Pala mec.FL4/D, FL4/L, FL4/C	8035.01.265	FIAT-OM CARRELLI ELEVATORI	DIM20, DIM25	3 Cil.		DIM30, DIM35	4 Cil.		DM12, DM15	3 Cil.	STORE	402/404	-																																																																																	
FIAT-HITACHI	Pala mec.FL4/D, FL4/L, FL4/C	8035.01.265																																																																																																	
FIAT-OM CARRELLI ELEVATORI	DIM20, DIM25	3 Cil.																																																																																																	
	DIM30, DIM35	4 Cil.																																																																																																	
	DM12, DM15	3 Cil.																																																																																																	
STORE	402/404	-																																																																																																	
	6005	1371163	FIAT Torpedo - Campagna Diesel dal 1968																																																																																																

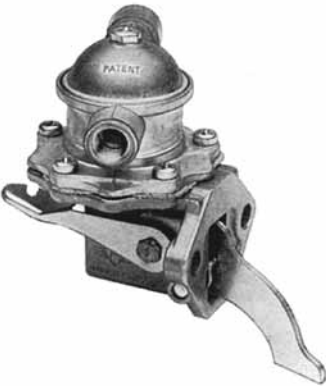

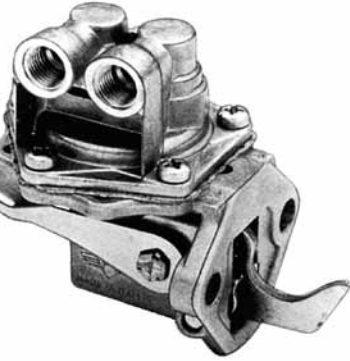

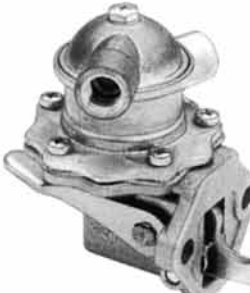

PUMP	PTZ number	original number	application																																																																																																																								
	6006	4673618 4709284 4740719 4757884 4802839 9.06.162.11 POC 102 PON 109	<table border="0"> <tr> <td>AIFO</td> <td>Industriale</td> <td>8051.05.200</td> <td>-</td> </tr> <tr> <td>FIAT-HITACHI</td> <td>Industriale</td> <td>8055.05.200, 8065.05.200</td> <td>-</td> </tr> <tr> <td></td> <td>Industriale</td> <td>8055.25.200 (5 Cyl.)</td> <td>-</td> </tr> <tr> <td></td> <td>Industriale</td> <td>8061.05.200 (6 Cyl.)</td> <td>-</td> </tr> <tr> <td></td> <td>Industriale</td> <td>8065.06.200</td> <td>-</td> </tr> <tr> <td></td> <td>Industriale</td> <td>8065.25.200 Turbodiesel</td> <td>-</td> </tr> <tr> <td></td> <td></td> <td>Tr. 666, 670, 680, 780, 855 6 Cil.</td> <td>-</td> </tr> <tr> <td>FIAT-OM CARRELLI ELEV. DI130</td> <td></td> <td>5 & 6 Cil.</td> <td>1979...</td> </tr> <tr> <td>IVECO</td> <td>Autocarro 40, 50/8, 40/35</td> <td>-</td> <td>1979...</td> </tr> <tr> <td></td> <td>Autocarro 40/35AB, 40A/B</td> <td>-</td> <td>-</td> </tr> <tr> <td></td> <td>Autocarro 50A/B/C, 55A/B</td> <td>-</td> <td>-</td> </tr> <tr> <td></td> <td>Autocarro 50NC/A, 50NC/B</td> <td>-</td> <td>1979...</td> </tr> <tr> <td></td> <td>Autocarro 50NC/C</td> <td>-</td> <td>1979...</td> </tr> <tr> <td></td> <td>Autocarro 50/10, 55/10, SSNC</td> <td>-</td> <td>-</td> </tr> <tr> <td>1979...</td> <td>Autocarro 50/8, 55/8, 65/10</td> <td>-</td> <td>-</td> </tr> <tr> <td></td> <td>Autocarro 55NC/A, 55NC/B</td> <td>-</td> <td>1979...</td> </tr> <tr> <td></td> <td>Autocarro 55NC/C</td> <td>-</td> <td>1979...</td> </tr> <tr> <td></td> <td>Autocarro bi h N3/4</td> <td>-</td> <td>1979...</td> </tr> <tr> <td></td> <td>Autocarro 65 A/B/C, 70 A/B</td> <td>-</td> <td>-</td> </tr> <tr> <td></td> <td>Autocarro 70/10, 75/10</td> <td>-</td> <td>-</td> </tr> <tr> <td></td> <td>Industriale</td> <td>D.8041.05.260</td> <td>-</td> </tr> <tr> <td></td> <td>Industriale</td> <td>D.8045.25.382</td> <td>-</td> </tr> <tr> <td></td> <td>Industriale</td> <td>D.8051.05.200</td> <td>-</td> </tr> <tr> <td></td> <td>Industriale</td> <td>D.8055.05.200/205/250</td> <td>-</td> </tr> <tr> <td></td> <td>Industriale</td> <td>D.8055.25.210</td> <td>-</td> </tr> <tr> <td></td> <td>Industriale</td> <td>D.8060.05.245/246/270/271-</td> <td>-</td> </tr> <tr> <td></td> <td>Industriale</td> <td>D.8061.05.260/300</td> <td>-</td> </tr> <tr> <td></td> <td>Industriale</td> <td>D.8062.05.270</td> <td>-</td> </tr> <tr> <td></td> <td>Industriale</td> <td>D.8065.05.220/289/290</td> <td>-</td> </tr> <tr> <td></td> <td>Industriale</td> <td>D.8065.05.295/297/300/32</td> <td>-</td> </tr> </table>	AIFO	Industriale	8051.05.200	-	FIAT-HITACHI	Industriale	8055.05.200, 8065.05.200	-		Industriale	8055.25.200 (5 Cyl.)	-		Industriale	8061.05.200 (6 Cyl.)	-		Industriale	8065.06.200	-		Industriale	8065.25.200 Turbodiesel	-			Tr. 666, 670, 680, 780, 855 6 Cil.	-	FIAT-OM CARRELLI ELEV. DI130		5 & 6 Cil.	1979...	IVECO	Autocarro 40, 50/8, 40/35	-	1979...		Autocarro 40/35AB, 40A/B	-	-		Autocarro 50A/B/C, 55A/B	-	-		Autocarro 50NC/A, 50NC/B	-	1979...		Autocarro 50NC/C	-	1979...		Autocarro 50/10, 55/10, SSNC	-	-	1979...	Autocarro 50/8, 55/8, 65/10	-	-		Autocarro 55NC/A, 55NC/B	-	1979...		Autocarro 55NC/C	-	1979...		Autocarro bi h N3/4	-	1979...		Autocarro 65 A/B/C, 70 A/B	-	-		Autocarro 70/10, 75/10	-	-		Industriale	D.8041.05.260	-		Industriale	D.8045.25.382	-		Industriale	D.8051.05.200	-		Industriale	D.8055.05.200/205/250	-		Industriale	D.8055.25.210	-		Industriale	D.8060.05.245/246/270/271-	-		Industriale	D.8061.05.260/300	-		Industriale	D.8062.05.270	-		Industriale	D.8065.05.220/289/290	-		Industriale	D.8065.05.295/297/300/32	-
AIFO	Industriale	8051.05.200	-																																																																																																																								
FIAT-HITACHI	Industriale	8055.05.200, 8065.05.200	-																																																																																																																								
	Industriale	8055.25.200 (5 Cyl.)	-																																																																																																																								
	Industriale	8061.05.200 (6 Cyl.)	-																																																																																																																								
	Industriale	8065.06.200	-																																																																																																																								
	Industriale	8065.25.200 Turbodiesel	-																																																																																																																								
		Tr. 666, 670, 680, 780, 855 6 Cil.	-																																																																																																																								
FIAT-OM CARRELLI ELEV. DI130		5 & 6 Cil.	1979...																																																																																																																								
IVECO	Autocarro 40, 50/8, 40/35	-	1979...																																																																																																																								
	Autocarro 40/35AB, 40A/B	-	-																																																																																																																								
	Autocarro 50A/B/C, 55A/B	-	-																																																																																																																								
	Autocarro 50NC/A, 50NC/B	-	1979...																																																																																																																								
	Autocarro 50NC/C	-	1979...																																																																																																																								
	Autocarro 50/10, 55/10, SSNC	-	-																																																																																																																								
1979...	Autocarro 50/8, 55/8, 65/10	-	-																																																																																																																								
	Autocarro 55NC/A, 55NC/B	-	1979...																																																																																																																								
	Autocarro 55NC/C	-	1979...																																																																																																																								
	Autocarro bi h N3/4	-	1979...																																																																																																																								
	Autocarro 65 A/B/C, 70 A/B	-	-																																																																																																																								
	Autocarro 70/10, 75/10	-	-																																																																																																																								
	Industriale	D.8041.05.260	-																																																																																																																								
	Industriale	D.8045.25.382	-																																																																																																																								
	Industriale	D.8051.05.200	-																																																																																																																								
	Industriale	D.8055.05.200/205/250	-																																																																																																																								
	Industriale	D.8055.25.210	-																																																																																																																								
	Industriale	D.8060.05.245/246/270/271-	-																																																																																																																								
	Industriale	D.8061.05.260/300	-																																																																																																																								
	Industriale	D.8062.05.270	-																																																																																																																								
	Industriale	D.8065.05.220/289/290	-																																																																																																																								
	Industriale	D.8065.05.295/297/300/32	-																																																																																																																								
	6006/3	4800420 4802838 FT-002/1	<table border="0"> <tr> <td>IVECO</td> <td>Autocarro 65.9</td> <td>8040.5</td> <td>-</td> </tr> <tr> <td></td> <td>Industriale</td> <td>8040.05.200 - 8040.25.200</td> <td>-</td> </tr> <tr> <td></td> <td></td> <td>D.8040.05.200/203/233/290</td> <td>-</td> </tr> <tr> <td></td> <td></td> <td>D.8040.25R.230/231/233/234-</td> <td>-</td> </tr> <tr> <td></td> <td></td> <td>D.8040.25.200/201/202</td> <td>-</td> </tr> <tr> <td></td> <td></td> <td>D.8040.25.203/207/208</td> <td>-</td> </tr> <tr> <td></td> <td></td> <td>D.8040.25.221/222/224/225</td> <td>-</td> </tr> <tr> <td></td> <td></td> <td>D.8060.05R.206</td> <td>-</td> </tr> <tr> <td></td> <td></td> <td>D.8060.05.200 e var.</td> <td>-</td> </tr> <tr> <td></td> <td></td> <td>D.8060.05.248/260/266</td> <td>-</td> </tr> <tr> <td></td> <td></td> <td>D.8060.05.280/284/289</td> <td>-</td> </tr> <tr> <td></td> <td>Veicolo 65.12, 79.12, 79.14</td> <td>-</td> <td>-</td> </tr> </table>	IVECO	Autocarro 65.9	8040.5	-		Industriale	8040.05.200 - 8040.25.200	-			D.8040.05.200/203/233/290	-			D.8040.25R.230/231/233/234-	-			D.8040.25.200/201/202	-			D.8040.25.203/207/208	-			D.8040.25.221/222/224/225	-			D.8060.05R.206	-			D.8060.05.200 e var.	-			D.8060.05.248/260/266	-			D.8060.05.280/284/289	-		Veicolo 65.12, 79.12, 79.14	-	-																																																																								
IVECO	Autocarro 65.9	8040.5	-																																																																																																																								
	Industriale	8040.05.200 - 8040.25.200	-																																																																																																																								
		D.8040.05.200/203/233/290	-																																																																																																																								
		D.8040.25R.230/231/233/234-	-																																																																																																																								
		D.8040.25.200/201/202	-																																																																																																																								
		D.8040.25.203/207/208	-																																																																																																																								
		D.8040.25.221/222/224/225	-																																																																																																																								
		D.8060.05R.206	-																																																																																																																								
		D.8060.05.200 e var.	-																																																																																																																								
		D.8060.05.248/260/266	-																																																																																																																								
		D.8060.05.280/284/289	-																																																																																																																								
	Veicolo 65.12, 79.12, 79.14	-	-																																																																																																																								
	6007	6416.6585.07 283.6585.31	<table border="0"> <tr> <td>FERRARI</td> <td colspan="3"> Trattore MC 60 RT con mot. Lombardini LDA 96/97 Trattore MC 60 con mot. Lombardini LDA 91/96/97 Motocoltivatori MC 64/68 con mot. Lombardini 71/80 Motocoltivatori 72 con mot. Lombardini 520 Motocoltivatori 72 Super con mot. Lombardini 520 Motofalciatrice 702/703 con mot. Lombardini LDA 80 Motofalciatrice 703/705 con mot. Lombardini LDA 80 </td> </tr> <tr> <td>GOLDONI</td> <td colspan="3"> Motocoltivatore Special con mot. Lombardini LDA 80/451 Motocoltivatore Export con mot. Lombardini LDA 91/97 </td> </tr> <tr> <td>LOMBARDINI</td> <td colspan="3"> Motori LDA 80 e derivati </td> </tr> </table>	FERRARI	Trattore MC 60 RT con mot. Lombardini LDA 96/97 Trattore MC 60 con mot. Lombardini LDA 91/96/97 Motocoltivatori MC 64/68 con mot. Lombardini 71/80 Motocoltivatori 72 con mot. Lombardini 520 Motocoltivatori 72 Super con mot. Lombardini 520 Motofalciatrice 702/703 con mot. Lombardini LDA 80 Motofalciatrice 703/705 con mot. Lombardini LDA 80			GOLDONI	Motocoltivatore Special con mot. Lombardini LDA 80/451 Motocoltivatore Export con mot. Lombardini LDA 91/97			LOMBARDINI	Motori LDA 80 e derivati																																																																																																														
FERRARI	Trattore MC 60 RT con mot. Lombardini LDA 96/97 Trattore MC 60 con mot. Lombardini LDA 91/96/97 Motocoltivatori MC 64/68 con mot. Lombardini 71/80 Motocoltivatori 72 con mot. Lombardini 520 Motocoltivatori 72 Super con mot. Lombardini 520 Motofalciatrice 702/703 con mot. Lombardini LDA 80 Motofalciatrice 703/705 con mot. Lombardini LDA 80																																																																																																																										
GOLDONI	Motocoltivatore Special con mot. Lombardini LDA 80/451 Motocoltivatore Export con mot. Lombardini LDA 91/97																																																																																																																										
LOMBARDINI	Motori LDA 80 e derivati																																																																																																																										
	6008	6416.6585.13	<table border="0"> <tr> <td>GOLDONI</td> <td colspan="3"> Motocoltivatori a benzina (questa pompa è stata sostituita dalla 6009 dal maggio 1975, siano motori con o senza i motorini di avviamento) </td> </tr> <tr> <td>LOMBARDINI</td> <td colspan="3"> Motori senza motorino di avviamento (fino aprile '75) tipo LA 400/490 </td> </tr> </table>	GOLDONI	Motocoltivatori a benzina (questa pompa è stata sostituita dalla 6009 dal maggio 1975, siano motori con o senza i motorini di avviamento)			LOMBARDINI	Motori senza motorino di avviamento (fino aprile '75) tipo LA 400/490																																																																																																																		
GOLDONI	Motocoltivatori a benzina (questa pompa è stata sostituita dalla 6009 dal maggio 1975, siano motori con o senza i motorini di avviamento)																																																																																																																										
LOMBARDINI	Motori senza motorino di avviamento (fino aprile '75) tipo LA 400/490																																																																																																																										





PUMP	PTZ number	original number	application
	6009	6416.6585.25 6416.6585.26	LOMBARDINI Motori LA 400 - LA 490 e derivati (dal 4/75) con o senza motorini di Avviamento
	6010	Fispa 401310	LANDINI 4000 Trattore con pompa iniezione SPICA Mignon
	6011	Fispa 403203 Spica 976043	LANDINI Trattore 4000 con pompa iniezione SPICA Mignon
	6012	Fispa 401617 501521 VM 1518004 3.518.001	LOMBARDINI Supe SLANZI DVA 1000 VM Motori SU 104 - 106 - 954 - 956 dal '65
	6013	904.6585.022 904.6585.22 9.06.233.11	LOMBARDINI Industriale Diesel 8LD600,8LD602(6r8) Industriale Diesel 904 a derivati
	6014	Same 2.4519.010.0	SAME Trattori sino al 1970 (differisce dalla pompa 6040 per la filettatura dei Raccordi)



PUMP	PTZ number	original number	application
	6015	Same 2.45.19.120.0 2.45.19.150.0	SAME SERNAGIOTTO Trattori Minitaurof Drago 100 - Motore 986 L - Aurora Motore Renault
	6016	AC-UF 7950325 7950783 Perkins 2641362	AVELING BARFORD Dumper (Perkins SA 4) '58/'59 Road Roller (Perkins 6D 4) '55/'59 CHAMBERLAIN Champion Tractor (Perkins 4/270 TA) CLARK EQUIPMENT Serie 60 Fork Truck (Perkins 4/270) INTERNATIONAL HARVESTER B 450 Tractor (Perkins 4/270) MARSHALL TPJ Road Roller (Perkins 4/203) Trackmarshall (Perkins 4/270) MASSEY FERGUSON Model 685 Combine (Perkins 4A/270) dal '63 Model 780 Combine (Perkins L4/TA) '59 Model 780 Combine (Perkins 4A/270) '58/'63 Model 788 Combine (Perkins 4A/270) dal '63 PERKINS 6DA Aveling Barford Road Roller '55/'59 L4TA Massey Ferguson 780 Combine '59 SA4 Aveling Barford Dumper '58/'59 4/270 Cockshutt 560 Tractor 4/270 International Harvester B 450 Tractor 4/270 Massey Ferguson 780/788 Combine '58/'63 4/270 Massey Ferguson 685/780/788 Combine dal '63
	6017	AC-F6 7971280 7950695 7971263 7950776 7971241 Ford 109 E 9350 B	FORD (Thames) Trucks & Vans 5,7 cwt ('61/'65) FORD CARS New Anglia - Capri - Cortina - Corsair FORD INDUSTRIAL ENGINES Kent Marine LOTUS CARS Mot. Ford 105 E - Seven II ^o - Super Seven 109 E Elan 1558 cc. - Elite ('63/'64) MORGAN 65 4/4 serie III - IV - V 1600 ('60)





PUMP	PTZ number	original number	application
	<p>6018</p>	<p>AC-YD 7971051 7950188 7950065</p> <p>Ford 502 E 9350</p>	<p>ALBION BEDFORD</p> <p>Nimbus EN 250 ('60) TD Truck (200/220 CU in Diesel) TJ Truck (Eng. 45774-200/220 CU in Diesel)</p> <p>CAV DIESEL INJECTOR Bedford TD e TJ (Eng. 45774 - 200/220 CU) ('58/'65) International Harvester BMD 6 e TTD 6 Tractors</p> <p>FORD COMMERCIAL Thames Trade (4 cyl. Diesel) '57/'65 2/3 Ton. (4 cyl. Diesel) '54/'57</p> <p>FORD INDUSTRIAL ENGINES 4 Cyl. C/eq. Simms P4145 - P4178 - P4193 6 Cyl. c/eq. Simms P4316</p> <p>FORD TRACTORS Major - Super Major (con Exhauster) '54/'62</p>
	<p>6019</p>	<p>AC-YJ 7950308 7950427</p> <p>Perkins 30485 35275 36205</p> <p>Ford 957 E 9350 B</p> <p>Simms 24797 A 461.110</p>	<p>ALLIS CHALMERS BEDFORD</p> <p>Combines (Perkins P3/144) B 272 Tractor (Perkins 3B/152) '57/'60 TJ Truck (Eng. 45775 200/220 CU in Diesel) TK Truck (200/220 CU in Diesel)</p> <p>BEDFORD INDUSTRIAL ENGINES B 7B (200 CU in Diesel) '60/'67 B 10 (220 CU in Diesel)</p> <p>CAV DIESEL INJECTORS Perkins P/3144 Engine</p> <p>FORD TRACTORS Dexta Light '57/'62</p> <p>INTERNATIONAL HARVESTER BC 264 Petrol Engine B 275 Tractor (3B/152)</p> <p>MASSEY FERGUSON M odel TE 20 Tractor (Perkins P31144) '57</p> <p>PERKINS F3 (Simms in. P4609) P3 Hispania (Simms in. P4588 - P4442 - P4696) P3 TA Trojan 20 cwt '56/'57 P3 TA Trojan 25 cwt (Ch. 8845) '59/'60 P31144 Ind. British Hoist Crane (Floating) '58 P3/144 Ind. Ford Dexta Tractor (Simms in. P4180) '59/'62 3B1152 Allis Chalmers B 272 Tractor '57/'60 3B/152 International Harvester B 275 Tractor 4/99 Morris Oxford II '58/'59 P3/144 Allis Chalmers Combine Harvester P3/144 Fordson Dexta Tractors '57/'59 P3/144 TA Allis Chalmers B e D 272 Tractors P31144 TA Bristol Tractor 22 P3/144 Massey Ferguson TE 20 Tractor 20 cwt (Perkins P3) '56/'57 25 cwt (Ch. 8845 Perkins P3) '57/'60</p> <p>TROJAN</p>



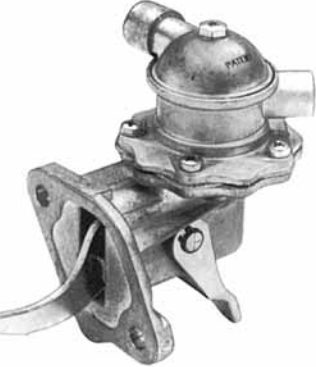

PUMP	PTZ number	original number	application	
	6020	Barreiros 4011072332/A 4011431820	BARREIROS	Motore C 60 - Campagnola Diesel mot. C60
	6021	Sev 85530	BERNARD	Moteurs Diesel 32
	6022	Sev 206.06502.46 CN	BERNARD PEUGEOT	Moteurs Diesel 32 dal 1970 404 Diesel versione Berlina e Taxi dal 12/70
	6023	25061522 25066376 25066377 2641308 461-109 461-169 502E9350 590E9350 7950065 7950188 7950426 7971051 A24796 AE-006/1 AK-106 FP109	DALE ELECTRIC FORD HUNSLET HYDROVANE LANSING GAGNALL MASSEY FERGUSON PERKINS TOWMOTOR	Generatore elettrico Perkins D3.152 1968... Industriale 4 Cil. P4250/51, P4347/48 - Industriale 4 Cil. Simms P4145/78, - Industriale 6 Cil. Simms P4316, P4354 - Industriale 6 Cil. Simms P4353 80 HP - Trattore Perkins D3.152 - Compressore 856T, CFM Perkins D3.152 - FLT Perkins D3.152 - Tr.122 Perkins 3.152 - Industriale D3.152 - 560P FLT Perkins D3.152 -
	6024	AC-FH 7950477 David Brown C902135 461.148 25061515 461-148 7950899 8909944	DAVID BROWN	850 Diesel dal '54/'64 850 4 cyl. Diesel '62/'64 950 Diesel dal '60/'62 990 Diesel dal '61/'64



PUMP	PTZ number	original number	application			
	6025	AC-YD 7990020 Simms A 505117/2 461.233 715 F 9350 AA	FORD COMMERCIAL. Transit Van (Ford 2/4 Diesel) 6 cyl. High Speed Diesel dal '72 SIMMS Ford "York" dal '69 Intercambiabile con pompa originale la cui flangia porta il numero 0020			
	6026	VM 3.518.001 1.518.004 3.518.0002A 3.518.001	SLAN11 VM	Industriale Industriale Industriale Industriale	DVA 1000 100 SI 104,106 SU 954,956 SU	- - ...1965 ...1965
	6027	Arona 19064	ARONA	Motori marini serie C.295 LL		
	6028		ERON			
	6029	Same 2.4519.090.0	SAME			
	6030	Slanzi 405036 405039 Sav 6012/220 9.06.061.00	SLANZI	Motori DVA 700 - 920 - 1030		

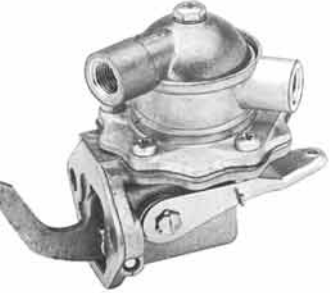
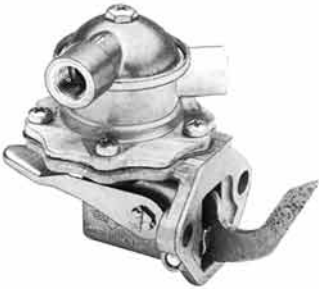

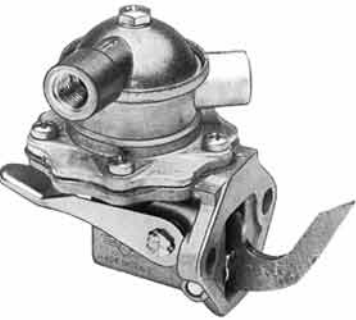

PUMP	PTZ number	original number	application
	6031	Fiat 4644126 4667668 4718364	FIAT Camioncino e Furgone 1100 TN 1 Diesel 241 AT - 241 F - 241 M-F 241 N - 241 TM (con motore 237 A.000) '73
	6032	Fispa 4015.22	
	6033	Same 2.4519.160.0 2.4519.100.0 2.4519.190.0	ITMA Trattore A 352 con mot. Same 982L 2 cil. 34 HP - dal '78 Trattore A 503 con mot. Same 983L 3 cil. 53 HP - dal '78 LAMBORGHINI Trattore R 235 con mot. Same 982L 2 cil. 34 HP Trattore C 553 con mot. Same 983L 3 cil. 53 HP Trattore C 653 con mot. Same 1053L 3 cil. 62 HP Trattore R 654 con mot. Same 984P 4 cil. 67 HP Trattore R 854 con mot. Same 1054P 4 cil. 82 HP - dal 1978 SAME Trattore Sirenetta con mot. 982L 2 cil. 30 HP Trattore Delfino con mot. 982L 2 cil. 34 HP Trattore Aurora con mot. 983L 3 cil. 45 HP Trattore Falcone e Falcon C con mot. 983L 3 cil. 50 HP Trattore Minitauro e Minitauro C con mot. 1053L 3 cil. 60 HP Trattore Corsaro con mot. 984L 4 cil. 67 HP Trattore Saturno con mot. 1054L 4 cil. 78 HP Motori industriali tipo 982L - 983L - 984L - 1053L - 1054L dal 1978
	6034	AC-YD 7950073 7950182 7950101 7950186 Standard 200292 - 203255 Karrier P45899 M. Ferguson 826.154.M91	COMMER KARRIER MASSEY FERGUSON MK V 15 - 20 - 25 - 30 cwt (Diesel) '56/'63 Bantam MK V (Light Diesel) '56/'58 Diesel '54/'55 FE 35 Tractor (Perkins 23 C Diesel) fino mot. SJ37181 E '56/'57 Model 20 Tractor (Diesel) '56/'57 PERKINS STANDARD Z3C - Massey Ferguson FE 35 Tr. fino mot. SJ37181 E '56/'57 London Taxi '55/'56 - Vanguard Diesel '54/'67 12 cwt Delivery Van e Pick-up Diesel '60

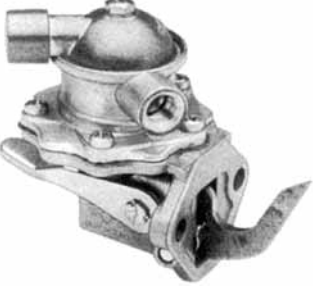
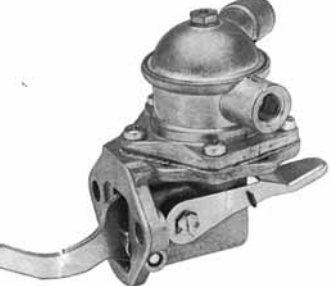

PUMP	PTZ number	original number	application																																																																																							
	6035	AC-FG 7950776	LOTUS Cars: Elite ('63/'64)																																																																																							
	6036	AC-YD 7990395 CAV 509943 508267 506401/2 461.279	FORD Furgoni Transit con equipaggiamento CAV dal 1973 FORD COMMERCIAL Serie York Diesel dal '73 Transit Van (2400 Ford) dal maggio '72 (Questa pompa e adattabile solo per pompe che hanno il numero 0395 sotto la flangia)																																																																																							
	6037	13H3374 13H3375 25061494 25066393 461-170 461-171 7950300 7950773 7971072 7971073 808137 808313 FP170 IC-013 IC-014 PON 115	<table border="0"> <tr> <td>LEYLAND - ROVER 255, 262, 270, 272</td> <td>4/98 DT, NT</td> <td>-</td> </tr> <tr> <td>344</td> <td>3,4 TD</td> <td>-</td> </tr> <tr> <td>Boxer BX 1000</td> <td>5,1 Lit. V. Diesel</td> <td>...1972</td> </tr> <tr> <td>Boxer BX 1000, 1160, 1200, 1300</td> <td></td> <td>..1972</td> </tr> <tr> <td>Boxer BX 1200, 1300, 16TA, 16TF</td> <td>6/98 Diesel</td> <td>1973...</td> </tr> <tr> <td>Boxer BX 984, 1000, 1160</td> <td>6/98 Diesel</td> <td>1973...</td> </tr> <tr> <td>Boxer DV/NV</td> <td>6/98 Diesel</td> <td>1973...</td> </tr> <tr> <td>Bus Viking FF 1100</td> <td>6/98 Diesel</td> <td>1974...</td> </tr> <tr> <td>FG 350, 360, 550, 700</td> <td>3,8 Lit. Diesel</td> <td>1970...</td> </tr> <tr> <td>FG 350, 360, 550, 700</td> <td>4/98 Diesel</td> <td>1973...</td> </tr> <tr> <td>FG 900</td> <td>5,1 8 5,7 Lit. V. Diesel</td> <td>1970-1972</td> </tr> <tr> <td>FG 900</td> <td>6/98 Diesel</td> <td>1973...</td> </tr> <tr> <td>FGK 100</td> <td>5,1 & 5,7 Lit. V. Diesel</td> <td>...1970</td> </tr> <tr> <td>FM 420</td> <td>3,8 Lit. Diesel</td> <td>-</td> </tr> <tr> <td>Skidded Units</td> <td>4/98 NT</td> <td>-</td> </tr> <tr> <td>Terrier 360, 420, 600</td> <td>4/98 Diesel</td> <td>1973...</td> </tr> <tr> <td>Terrier 650 Tr., 750 Tr.</td> <td>3,8 lit. Diesel</td> <td>1971-1972</td> </tr> <tr> <td>Terrier 650, 750, 850, 950</td> <td>5,1 Lit.</td> <td>1973-8/83</td> </tr> <tr> <td>Terrier 830, 900 WF</td> <td>4/98 Diesel</td> <td>1973...</td> </tr> <tr> <td>Terrier 950 Tr.</td> <td>5,7 Lit. V. Diesel</td> <td>1971-1973</td> </tr> <tr> <td>Tr. 384 Nuffield</td> <td>4/65 3,8 T, TA, TD</td> <td>-</td> </tr> <tr> <td>Tr. Nuffield 2100, 4100</td> <td>6/98 DT, NT</td> <td>-</td> </tr> <tr> <td>Tr. Nuffield 285, 485</td> <td>6/98 DT, NT</td> <td>-</td> </tr> <tr> <td>WF 3h0, 420, 600, 830, 900</td> <td>3,8 lit. Diesel</td> <td>1970...</td> </tr> <tr> <td>WF 830, 900, 1025</td> <td>5,1 Lit. V. Diesel</td> <td>1970...</td> </tr> <tr> <td>WF 830, 900, 1025, 1160</td> <td>5,7 Lit. V Diesel</td> <td>1970-1972</td> </tr> <tr> <td>WFK 100, 120, 140</td> <td>5,1 & 5,7 Lit. V. Diesel</td> <td>...1970</td> </tr> <tr> <td>WFK, WFK 30, 40, 60, 80</td> <td>3,8 Lit. Diesel</td> <td>1965-1970</td> </tr> <tr> <td>NUFFIELD Tractor 3/45, 4/65</td> <td>-</td> <td>1968...</td> </tr> </table>	LEYLAND - ROVER 255, 262, 270, 272	4/98 DT, NT	-	344	3,4 TD	-	Boxer BX 1000	5,1 Lit. V. Diesel	...1972	Boxer BX 1000, 1160, 1200, 1300		..1972	Boxer BX 1200, 1300, 16TA, 16TF	6/98 Diesel	1973...	Boxer BX 984, 1000, 1160	6/98 Diesel	1973...	Boxer DV/NV	6/98 Diesel	1973...	Bus Viking FF 1100	6/98 Diesel	1974...	FG 350, 360, 550, 700	3,8 Lit. Diesel	1970...	FG 350, 360, 550, 700	4/98 Diesel	1973...	FG 900	5,1 8 5,7 Lit. V. Diesel	1970-1972	FG 900	6/98 Diesel	1973...	FGK 100	5,1 & 5,7 Lit. V. Diesel	...1970	FM 420	3,8 Lit. Diesel	-	Skidded Units	4/98 NT	-	Terrier 360, 420, 600	4/98 Diesel	1973...	Terrier 650 Tr., 750 Tr.	3,8 lit. Diesel	1971-1972	Terrier 650, 750, 850, 950	5,1 Lit.	1973-8/83	Terrier 830, 900 WF	4/98 Diesel	1973...	Terrier 950 Tr.	5,7 Lit. V. Diesel	1971-1973	Tr. 384 Nuffield	4/65 3,8 T, TA, TD	-	Tr. Nuffield 2100, 4100	6/98 DT, NT	-	Tr. Nuffield 285, 485	6/98 DT, NT	-	WF 3h0, 420, 600, 830, 900	3,8 lit. Diesel	1970...	WF 830, 900, 1025	5,1 Lit. V. Diesel	1970...	WF 830, 900, 1025, 1160	5,7 Lit. V Diesel	1970-1972	WFK 100, 120, 140	5,1 & 5,7 Lit. V. Diesel	...1970	WFK, WFK 30, 40, 60, 80	3,8 Lit. Diesel	1965-1970	NUFFIELD Tractor 3/45, 4/65	-	1968...
LEYLAND - ROVER 255, 262, 270, 272	4/98 DT, NT	-																																																																																								
344	3,4 TD	-																																																																																								
Boxer BX 1000	5,1 Lit. V. Diesel	...1972																																																																																								
Boxer BX 1000, 1160, 1200, 1300		..1972																																																																																								
Boxer BX 1200, 1300, 16TA, 16TF	6/98 Diesel	1973...																																																																																								
Boxer BX 984, 1000, 1160	6/98 Diesel	1973...																																																																																								
Boxer DV/NV	6/98 Diesel	1973...																																																																																								
Bus Viking FF 1100	6/98 Diesel	1974...																																																																																								
FG 350, 360, 550, 700	3,8 Lit. Diesel	1970...																																																																																								
FG 350, 360, 550, 700	4/98 Diesel	1973...																																																																																								
FG 900	5,1 8 5,7 Lit. V. Diesel	1970-1972																																																																																								
FG 900	6/98 Diesel	1973...																																																																																								
FGK 100	5,1 & 5,7 Lit. V. Diesel	...1970																																																																																								
FM 420	3,8 Lit. Diesel	-																																																																																								
Skidded Units	4/98 NT	-																																																																																								
Terrier 360, 420, 600	4/98 Diesel	1973...																																																																																								
Terrier 650 Tr., 750 Tr.	3,8 lit. Diesel	1971-1972																																																																																								
Terrier 650, 750, 850, 950	5,1 Lit.	1973-8/83																																																																																								
Terrier 830, 900 WF	4/98 Diesel	1973...																																																																																								
Terrier 950 Tr.	5,7 Lit. V. Diesel	1971-1973																																																																																								
Tr. 384 Nuffield	4/65 3,8 T, TA, TD	-																																																																																								
Tr. Nuffield 2100, 4100	6/98 DT, NT	-																																																																																								
Tr. Nuffield 285, 485	6/98 DT, NT	-																																																																																								
WF 3h0, 420, 600, 830, 900	3,8 lit. Diesel	1970...																																																																																								
WF 830, 900, 1025	5,1 Lit. V. Diesel	1970...																																																																																								
WF 830, 900, 1025, 1160	5,7 Lit. V Diesel	1970-1972																																																																																								
WFK 100, 120, 140	5,1 & 5,7 Lit. V. Diesel	...1970																																																																																								
WFK, WFK 30, 40, 60, 80	3,8 Lit. Diesel	1965-1970																																																																																								
NUFFIELD Tractor 3/45, 4/65	-	1968...																																																																																								

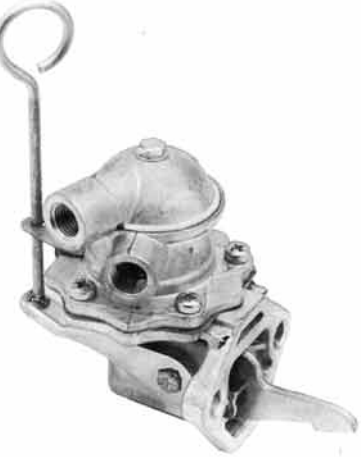

PUMP	PTZ number	original number	application			
	6038	2.4519.010.0 2.4519.010.01	SAME DEUTZ-FAHR GROUP Tr. Centauro 55 Tr. Puledro Tr. Tipi diversi (vecchi mod)			
	6039	4279496 4724652 4740996 4749880 4755893 9.06.136.11 POC 097 PON 105	ALFA ROMEO Furgone 30AR8, 32AR8 - ...6/1983 Furgone 35AR8, 40AR8 - ...6/1983 FIAT 131 Diesel 2000, 2500 ...6/1983 131 Marengo Diesel 2500 ...7/1983 132 Diesel 2000, 2500 ...6/1983 Argenta Diesel 2500 ...6/1983 Campagnola Diesel 2500 ...7/1983 IVECO Autocarro Daily (Tutu tipi) Diesel 2500 ...6/1983 Autocarro Grinta Diesel 2500 ...6/1983 Industriale 4 Cil. 8140.61.300 a der. ...6/1983			
	6040	2.4519.130.0	SAME DEUTZ-FAHR GROUP Tr. Atlanta 45 - 5/66-12/71 Tr. Centauro 60, Leone 70 - 5/66-3/71			
	6041	461-50 5506943 816042 PON 122	BEDFORD Blitz 2100 Diesel G.M. 1972-1977 CF Eurgone Diesel G.M. ...1977 OPEL Rekord D Diesel 9/72-8/77			
	6042	Slanzi 05030 405037 Savara 6007.33 9.06.019.00	SLANZI Motori DVA 460			





PUMP	PTZ number	original number	application
	6047	AC-FH 7971249	PERKINS SAVIEM 597 Saviem SM6-SM7-SM8-S9/596 6 cyl.
	6048	25061524 25066404 2641328 461-175 7971116 AK-104 FP175	LANDINI Tr. 6500 Perkins 4.203 - MASSEY FERGUSON Tr. 165, 300, HX21 Perkins 4AD.203 1966... Tr. DX45, HX211, MF165 Perkins 4AD.203 1966... Tr. MF 158, 158ET, 158Mk III Perkins AD4.203 Tr. MF 300, 302, 304 Perkins 4AD.203 - Tr. MF 304, 365, 3165S Perkins 4AD.203,4AD.203.1 - Tr. MF 3303, 3305 Perkins 4AD.203,4AD.203.1 1966... Tr. MF 560 Perkins D4.203 - Tr. MF 765 Perkins 4AD.203,4AD.203.1 -
	6049	AC-FH 7950839 Perkins 2641326	ALSTHOM DIESELAIR 2/3/4/5/6 Cyl. Motore Agrom. PERKINS 4/203 Willys Pick-up dal '64
	6050	AC-FH 7950621 Perkins 35218 32556 AC FH 7950383 461.123	HYSTER Ford Truck H40F (Perkins 4/203) P4/192 Combine Harvester 4/203 Ind. Hunslett Engineering 4/203 TA Fordson 801 Tractor MASSEY FERGUSON FE Tractor (Perkins P3/TA) P3 (Yugostavia) P3/TA Massey Ferguson FE 35 Tr. PERKINS P3/TA Massey Ferguson Starter Mot. A/203 - P4/192 4/203 TA Fordson 801 Tractor 4/203 Ind. Hunslett Engineering
	6051	461-205 7971320	ALSTHOM DIESELAIR Trattore Agrom 2/3/4/5/6 Cyl.

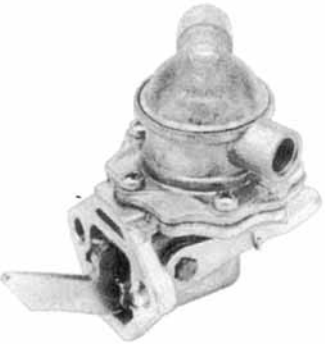





PUMP	PTZ number	original number	application																																																														
	6052	25066403 3950 461-246 50.00.592.768 50.00.044.183 7990084	<table border="0"> <tr> <td>ALFA ROMEO</td> <td>Furgone A19</td> <td>Perkins</td> <td>-</td> </tr> <tr> <td>RENAULT (RVI)</td> <td>SE4, SE5</td> <td>671</td> <td>1962...</td> </tr> <tr> <td>SAVIEM (RVI)</td> <td>Furgone Str2, SE3/4/5, SM5</td> <td></td> <td>712/720 4Cil.</td> </tr> <tr> <td></td> <td>Furgone Tp3, TP4</td> <td>712/720 4Cil.</td> <td>-</td> </tr> </table>	ALFA ROMEO	Furgone A19	Perkins	-	RENAULT (RVI)	SE4, SE5	671	1962...	SAVIEM (RVI)	Furgone Str2, SE3/4/5, SM5		712/720 4Cil.		Furgone Tp3, TP4	712/720 4Cil.	-																																														
ALFA ROMEO	Furgone A19	Perkins	-																																																														
RENAULT (RVI)	SE4, SE5	671	1962...																																																														
SAVIEM (RVI)	Furgone Str2, SE3/4/5, SM5		712/720 4Cil.																																																														
	Furgone Tp3, TP4	712/720 4Cil.	-																																																														
	6053	25061518 25066392 461-159 7950500 7971020 816038 91145758 A4021132 A4021133 AO-045 FPI 59 PON 113	<table border="0"> <tr> <td rowspan="8">BEDFORD</td> <td>C Truck, M Truck</td> <td>Diesel 330</td> <td>1970...</td> </tr> <tr> <td>P Autotelaio 300 8 330</td> <td>-</td> <td>-</td> </tr> <tr> <td>R Truck</td> <td>Diesel 54222...</td> <td></td> </tr> <tr> <td>TJ Truck CD Serie 300</td> <td>Diesel 160220...</td> <td></td> </tr> <tr> <td>TJ Truck CD Serie 330</td> <td>Diesel 160325...</td> <td>1967...</td> </tr> <tr> <td>TK Truck EDM,N,O,R,T,V,NRX3</td> <td>Diesel 330</td> <td>1967...</td> </tr> <tr> <td>TL</td> <td>Diesel 330</td> <td>1980...</td> </tr> <tr> <td>VA Autotelaio</td> <td>Diesel 300, 330</td> <td>-</td> </tr> </table>	BEDFORD	C Truck, M Truck	Diesel 330	1970...	P Autotelaio 300 8 330	-	-	R Truck	Diesel 54222...		TJ Truck CD Serie 300	Diesel 160220...		TJ Truck CD Serie 330	Diesel 160325...	1967...	TK Truck EDM,N,O,R,T,V,NRX3	Diesel 330	1967...	TL	Diesel 330	1980...	VA Autotelaio	Diesel 300, 330	-																																					
BEDFORD	C Truck, M Truck	Diesel 330	1970...																																																														
	P Autotelaio 300 8 330	-	-																																																														
	R Truck	Diesel 54222...																																																															
	TJ Truck CD Serie 300	Diesel 160220...																																																															
	TJ Truck CD Serie 330	Diesel 160325...	1967...																																																														
	TK Truck EDM,N,O,R,T,V,NRX3	Diesel 330	1967...																																																														
	TL	Diesel 330	1980...																																																														
	VA Autotelaio	Diesel 300, 330	-																																																														
	6056	AC-YJ 7950421 Perkins 32567 35567 461.108	<table border="0"> <tr> <td>BEARDMORE</td> <td>Taxi (Perkins 4/99) '60</td> <td></td> <td></td> </tr> <tr> <td>BEDFORD</td> <td>CA Van Diesel (Perkins 4/99) '61/'65</td> <td></td> <td></td> </tr> <tr> <td rowspan="2">CHRYSLER</td> <td>PA 1500/2500 (Perkins 4/108) '67</td> <td></td> <td></td> </tr> <tr> <td>PB Van Engine 108 U 13472 (Perkins 4/108) '67</td> <td></td> <td></td> </tr> <tr> <td rowspan="3">COMMER</td> <td>PA 1500/2500 (Perkins 4/108) '65</td> <td></td> <td></td> </tr> <tr> <td>1500 15 cwt Van (Perkins 4/99) '59/'65</td> <td></td> <td></td> </tr> <tr> <td>2500 15 cwt Van (Perkins 4/99) '59/'65</td> <td></td> <td></td> </tr> <tr> <td rowspan="2">FORD COMMERCIAL</td> <td>Thames 10 - 12 - 15 cwt - Van e Bus Diesel '61/'65</td> <td></td> <td></td> </tr> <tr> <td>10 - 12 - 15 cwt - Van pick-up Transporter Diesel</td> <td></td> <td></td> </tr> <tr> <td>MASSEY FERGUSON</td> <td>Model 630 Combine (Perkins A 4/107)</td> <td></td> <td></td> </tr> <tr> <td rowspan="7">PERKINS</td> <td>4/99 Beardmore Taxi dal '65</td> <td></td> <td></td> </tr> <tr> <td>4/99 Bedford CA Van '61/'64</td> <td></td> <td></td> </tr> <tr> <td>4/99 Commer 1500/2000 dal '65</td> <td></td> <td></td> </tr> <tr> <td>4/99 Ford 10 - 12 - 15 cwt Van '65</td> <td></td> <td></td> </tr> <tr> <td>4/99 Trojan 25 cwt Bus (dal ch. 8844) '58/'59</td> <td></td> <td></td> </tr> <tr> <td>A 4/99 Massey Ferguson 31-6 e 830 Combine (Francia) '58/'59</td> <td></td> <td></td> </tr> <tr> <td>A 4/107 Ford 10 - 12 - 15 cwt Van</td> <td></td> <td></td> </tr> <tr> <td>TROJAN</td> <td>A 4/107 Massey Ferguson 86/6 e 630 Combine - 4/108 Chrysler '67 Bus 12 passeggeri (Perkins 4/99) '58/'59</td> <td></td> <td></td> </tr> </table>	BEARDMORE	Taxi (Perkins 4/99) '60			BEDFORD	CA Van Diesel (Perkins 4/99) '61/'65			CHRYSLER	PA 1500/2500 (Perkins 4/108) '67			PB Van Engine 108 U 13472 (Perkins 4/108) '67			COMMER	PA 1500/2500 (Perkins 4/108) '65			1500 15 cwt Van (Perkins 4/99) '59/'65			2500 15 cwt Van (Perkins 4/99) '59/'65			FORD COMMERCIAL	Thames 10 - 12 - 15 cwt - Van e Bus Diesel '61/'65			10 - 12 - 15 cwt - Van pick-up Transporter Diesel			MASSEY FERGUSON	Model 630 Combine (Perkins A 4/107)			PERKINS	4/99 Beardmore Taxi dal '65			4/99 Bedford CA Van '61/'64			4/99 Commer 1500/2000 dal '65			4/99 Ford 10 - 12 - 15 cwt Van '65			4/99 Trojan 25 cwt Bus (dal ch. 8844) '58/'59			A 4/99 Massey Ferguson 31-6 e 830 Combine (Francia) '58/'59			A 4/107 Ford 10 - 12 - 15 cwt Van			TROJAN	A 4/107 Massey Ferguson 86/6 e 630 Combine - 4/108 Chrysler '67 Bus 12 passeggeri (Perkins 4/99) '58/'59		
BEARDMORE	Taxi (Perkins 4/99) '60																																																																
BEDFORD	CA Van Diesel (Perkins 4/99) '61/'65																																																																
CHRYSLER	PA 1500/2500 (Perkins 4/108) '67																																																																
	PB Van Engine 108 U 13472 (Perkins 4/108) '67																																																																
COMMER	PA 1500/2500 (Perkins 4/108) '65																																																																
	1500 15 cwt Van (Perkins 4/99) '59/'65																																																																
	2500 15 cwt Van (Perkins 4/99) '59/'65																																																																
FORD COMMERCIAL	Thames 10 - 12 - 15 cwt - Van e Bus Diesel '61/'65																																																																
	10 - 12 - 15 cwt - Van pick-up Transporter Diesel																																																																
MASSEY FERGUSON	Model 630 Combine (Perkins A 4/107)																																																																
PERKINS	4/99 Beardmore Taxi dal '65																																																																
	4/99 Bedford CA Van '61/'64																																																																
	4/99 Commer 1500/2000 dal '65																																																																
	4/99 Ford 10 - 12 - 15 cwt Van '65																																																																
	4/99 Trojan 25 cwt Bus (dal ch. 8844) '58/'59																																																																
	A 4/99 Massey Ferguson 31-6 e 830 Combine (Francia) '58/'59																																																																
	A 4/107 Ford 10 - 12 - 15 cwt Van																																																																
TROJAN	A 4/107 Massey Ferguson 86/6 e 630 Combine - 4/108 Chrysler '67 Bus 12 passeggeri (Perkins 4/99) '58/'59																																																																

PUMP	PTZ number	original number	application
	<p>6057</p>	<p>AC-YJ 7971304</p> <p>Perkins 2641314 461.204 6637821</p>	<p>BEDFORD BOLINDER MUNKTELL CHRYSLER</p> <p>CF Van 14 - 18 - 22 cwt (Perkins 4/108) '69/'73 ST 257 Combine (Perkins 4/108 TA) PB Van (Perkins 4/108) E (Spagna) PB Engine 108 U 13473 - 108 U 46250 dal '67 Fork Truck (Perkins 4/107) Transit Van (Perkins Diesel)</p> <p>COVENTRY CLIMAX FORD COMMERCIAL</p> <p>HYSTER PERKINS RANSOMERS - SIMMS - JEFFERIES</p> <p>Fork Truck H 20 - 25 E - H 20 - 30 D (Perkins 4/107) 4/108 Marine - 4/107 Combine (Perkins 4/107 A)</p>
	<p>6058</p>	<p>AC-YJ 7950607</p> <p>Perkins 2641305</p>	<p>MASSEY FERGUSON PERKINS</p> <p>Model 130 Tractor (Perkins A 4/107) dal '65 A 4/99 Massey Ferguson 825 Tractor (Frame) A 4/107 Massey Ferguson CKD A 4/107 Massey Ferguson 130 Tractor</p>
	<p>6059</p>	<p>25061505 25066373 323939 329-24810 329-62200 351-12150 461-115 7950461 FP115</p>	<p>LISTER PETTER HA, HB, LD, LS Diesel Air Cooled</p>
	<p>6060</p>	<p>AC-YD 7990046</p> <p>Lister 351-12150 461.240</p>	<p>LISTER PETTER SR 2 - 3 - 4 Cyl. (Motore Marino)</p>
	<p>6061</p>	<p>AC-VJ 7971040</p> <p>Perkins 2641310</p> <p>Massey Ferguson 883.770.M91 461.167</p>	<p>MASSEY FERGUSON PERKINS 135 Tractor 3/152 dal '66</p>

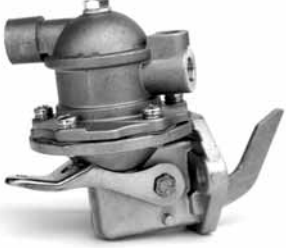
PUMP	PTZ number	original number	application		
	6062	25061514 25066402 2641326 2641327 461-147 60249 735145 7950885 AK-100	ACTIV FISCHER ALSTHOM DIESELAIR BEDFORD BOLINDER MUNKTELL CIAAS DRONNINGBORG PERKINS	Combine 800 Macchine Agricole CF Furgone Combine Compact 25 Combine Combine Industriale Jeep Willis Pick-up	Perkins 4.154 2, 3, 4, 5, 6 Cil. Perkins 4.154 Perkins 4.154 Perkins 4.154 Perkins 4.154 4.154, 4.203 4.203
	6063	25061530 2641333 461-193 7971262 911287 AK-107	CLARK EICHER FENWICK HYSTER LANCER BOSS LANDINI MASSEY FERGUSON PERKINS RUBERY OWEN VALTRA VALMET (SISU) YALE & TOWNE	C60/70/80 "B" CY40/60 Tr. 3355, 3356 FLT Fork Truck H40H Applic. diverse Tr. TL 1 hN MF 1080 Phase III Tr. MF 155,158 Tr. MF 195 Tr. MF 260 Tr. MF 295, 298 Tr. MF 560 Tr. MF 590X, 5955 Tr. MF 592 Tr. MF 595 Tr. MF 598 Industriale TC Serie FIT FLT D51 AT 40	Perkins 4.203 Perkins 4.203 Perkins 4.203 Perkins 4.203 Perkins 4.203 Perkins D4.203 Perkins 4.318 Perkins 4.318 Perkins 4A.318 Perkins D4.203 Perkins 4.318 Perkins 4.203 Perkins 4.318 Perkins 4.318 Perkins 4.318, 4.318.2 Perkins 4.318 A4.318, 4.203 Perkins 4.203 Perkins 4.203 Perkins 4.203
	6064	AC-H F 7990015 Perkins 2641334	PERKINS	4/203 V	



PUMP	PTZ number	original number	application																																																																																																																								
	6065	25061506 25061511 25061566 25066405 2641371 461-116 461-137 461-263 60252 781114 78997 78-1114 7950499 7950770 7990265 79-1113 AK-110 EP137	<table border="0"> <tr> <td>AEC</td> <td>AV 275, 312, 319, 470E</td> <td>-</td> <td>-</td> </tr> <tr> <td></td> <td>AV 470E, 590</td> <td>DPA</td> <td>-</td> </tr> <tr> <td></td> <td>AV 505 LHD</td> <td>-</td> <td>...1966</td> </tr> <tr> <td></td> <td>AV 690/58</td> <td>410 DPA</td> <td>-</td> </tr> <tr> <td></td> <td>IndustrialePerkins 6/305, 6/340</td> <td>-</td> <td>-</td> </tr> <tr> <td></td> <td>Reliance Express Coach</td> <td>-</td> <td>-</td> </tr> <tr> <td>ALLIS-CHALMERS</td> <td>Tr. BTL 120, 140,160, 200</td> <td>DPA</td> <td>1963...</td> </tr> <tr> <td>BRISTOL</td> <td>Titan 680, 690</td> <td>-</td> <td>-</td> </tr> <tr> <td>LEYLAND - ROVER</td> <td>Bus Atlantean 680, 690</td> <td>-</td> <td>1958-1965</td> </tr> <tr> <td></td> <td>Bus Eleetline FE30</td> <td>680, 690</td> <td>-</td> </tr> <tr> <td></td> <td>Bus Leopard, Victory</td> <td>680, 690</td> <td>1965...</td> </tr> <tr> <td></td> <td>Bus Worldmaster</td> <td>680, 690</td> <td>-</td> </tr> <tr> <td></td> <td>Tr. Scammel,Contractor AV760</td> <td>680</td> <td>-</td> </tr> <tr> <td>PERKINS</td> <td>Industriale6.357/7</td> <td>-</td> <td>-</td> </tr> <tr> <td></td> <td>Industriale/Marino</td> <td>6.288, 6.305, 6.340, 4.99</td> <td>1965...</td> </tr> <tr> <td>SISU (VALMET)</td> <td>BT69CR, 530 City</td> <td>Leyland 760</td> <td>-</td> </tr> <tr> <td></td> <td>R141, 142,149, M169</td> <td>Leyland 690</td> <td>-</td> </tr> <tr> <td>TAIBOT</td> <td>Dodge D405 3,5-5-6-7 Ton</td> <td>Perkins 6.305</td> <td>1965-1970</td> </tr> </table>	AEC	AV 275, 312, 319, 470E	-	-		AV 470E, 590	DPA	-		AV 505 LHD	-	...1966		AV 690/58	410 DPA	-		IndustrialePerkins 6/305, 6/340	-	-		Reliance Express Coach	-	-	ALLIS-CHALMERS	Tr. BTL 120, 140,160, 200	DPA	1963...	BRISTOL	Titan 680, 690	-	-	LEYLAND - ROVER	Bus Atlantean 680, 690	-	1958-1965		Bus Eleetline FE30	680, 690	-		Bus Leopard, Victory	680, 690	1965...		Bus Worldmaster	680, 690	-		Tr. Scammel,Contractor AV760	680	-	PERKINS	Industriale6.357/7	-	-		Industriale/Marino	6.288, 6.305, 6.340, 4.99	1965...	SISU (VALMET)	BT69CR, 530 City	Leyland 760	-		R141, 142,149, M169	Leyland 690	-	TAIBOT	Dodge D405 3,5-5-6-7 Ton	Perkins 6.305	1965-1970																																																
AEC	AV 275, 312, 319, 470E	-	-																																																																																																																								
	AV 470E, 590	DPA	-																																																																																																																								
	AV 505 LHD	-	...1966																																																																																																																								
	AV 690/58	410 DPA	-																																																																																																																								
	IndustrialePerkins 6/305, 6/340	-	-																																																																																																																								
	Reliance Express Coach	-	-																																																																																																																								
ALLIS-CHALMERS	Tr. BTL 120, 140,160, 200	DPA	1963...																																																																																																																								
BRISTOL	Titan 680, 690	-	-																																																																																																																								
LEYLAND - ROVER	Bus Atlantean 680, 690	-	1958-1965																																																																																																																								
	Bus Eleetline FE30	680, 690	-																																																																																																																								
	Bus Leopard, Victory	680, 690	1965...																																																																																																																								
	Bus Worldmaster	680, 690	-																																																																																																																								
	Tr. Scammel,Contractor AV760	680	-																																																																																																																								
PERKINS	Industriale6.357/7	-	-																																																																																																																								
	Industriale/Marino	6.288, 6.305, 6.340, 4.99	1965...																																																																																																																								
SISU (VALMET)	BT69CR, 530 City	Leyland 760	-																																																																																																																								
	R141, 142,149, M169	Leyland 690	-																																																																																																																								
TAIBOT	Dodge D405 3,5-5-6-7 Ton	Perkins 6.305	1965-1970																																																																																																																								
	6066	1.518.003 1.518.006 1.518.010 8.500.121	<table border="0"> <tr> <td>VM</td> <td>Industriale</td> <td>102 SU,103 SU</td> <td>..1980</td> </tr> <tr> <td></td> <td>Industriale</td> <td>104 SU/T 2,3,4 Cil.</td> <td>..1980</td> </tr> <tr> <td></td> <td>Industriale</td> <td>952 SU, 953 SU</td> <td>...1980</td> </tr> </table>	VM	Industriale	102 SU,103 SU	..1980		Industriale	104 SU/T 2,3,4 Cil.	..1980		Industriale	952 SU, 953 SU	...1980																																																																																																												
VM	Industriale	102 SU,103 SU	..1980																																																																																																																								
	Industriale	104 SU/T 2,3,4 Cil.	..1980																																																																																																																								
	Industriale	952 SU, 953 SU	...1980																																																																																																																								
	6067	05042263 25061495 25066409 2641372 2641374 2641375 2641377 34167 3679325 461-131 461-132 461-133 461-135 5043611 6637508 781113 7950598 7950730 7950764 7950765 7950766 7950768 AJR 2609 AK-096 D34265 FP133 PON 112	<table border="0"> <tr> <td>ACMAT</td> <td>Applic. diverse</td> <td>Perkins 6.354</td> <td>-</td> </tr> <tr> <td>ALLIS-CHALMERS (USA)</td> <td>4000 Applic. diverse</td> <td>Perkins 6.288, 6.305</td> <td>1965...</td> </tr> <tr> <td></td> <td>Tr. T1545</td> <td>Perkins 6.354</td> <td>-</td> </tr> <tr> <td>ARBOS</td> <td>Applic. diverse</td> <td>Perkins 6.354</td> <td>-</td> </tr> <tr> <td>ATKINSON</td> <td>L 1 266 PT</td> <td>Perkins 6.354</td> <td>-</td> </tr> <tr> <td>AVELING BARFORD</td> <td>Dump Truck RD017</td> <td>Leyland 680, 690</td> <td>11/1973...</td> </tr> <tr> <td></td> <td>Tr. AMIOOA</td> <td>Perkins 6.354</td> <td>-</td> </tr> <tr> <td>BOLINDER MUNKTELL</td> <td>5950</td> <td>Perkins 6.354</td> <td>1965-1970</td> </tr> <tr> <td>BRAUD</td> <td>505</td> <td>Perkins 6.354, TG.354.1</td> <td>-</td> </tr> <tr> <td>BROOME & WADE</td> <td>Compressore CR/CV 250</td> <td>Perkins 6.354</td> <td>-</td> </tr> <tr> <td>BROYT</td> <td>Escavatore</td> <td>Perkins 6.354</td> <td>-</td> </tr> <tr> <td>CATERPILLAR</td> <td>V160/300</td> <td>Perkins 6.354</td> <td>-</td> </tr> <tr> <td>CLARK</td> <td>Fork Tractor</td> <td>Perkins 6.354</td> <td>1966...</td> </tr> <tr> <td></td> <td>Tractor 45B</td> <td>Perkins 6.354</td> <td>-</td> </tr> <tr> <td>DENNIS</td> <td>Dart</td> <td>Perkins 6.354</td> <td>-</td> </tr> <tr> <td>DOUGLAS</td> <td>Tractive Units NS8/250</td> <td>Leyland 680, 690</td> <td>-</td> </tr> <tr> <td></td> <td>Tugmaster</td> <td>Perkins 6.354</td> <td>-</td> </tr> <tr> <td>DRONNINGBORG</td> <td>D1600</td> <td>Perkins 6.354</td> <td>-</td> </tr> <tr> <td>HEATHFIELD</td> <td>Dump Truck H20</td> <td>Leyland 690</td> <td>-</td> </tr> <tr> <td>HYDROMAC</td> <td>Escavatore 580</td> <td>Perkins 6.354</td> <td>-</td> </tr> <tr> <td>HYSTER</td> <td>Fork Truck H150, H250</td> <td>Perkins 6.354, 6.354.1</td> <td>-</td> </tr> <tr> <td></td> <td>Fork Truck HB100,H100C,RC150</td> <td>Perkins 6.305.1</td> <td>-</td> </tr> <tr> <td></td> <td>M300</td> <td>Perkins 6.354, 6.354.1</td> <td>-</td> </tr> <tr> <td>IMC</td> <td>C1600, C1800</td> <td>Perkins 6.354</td> <td>-</td> </tr> <tr> <td>INGERSOLL</td> <td>Compressore DRF 250</td> <td>Perkins 6.354</td> <td>-</td> </tr> <tr> <td>INTERNATIONAL HARV.</td> <td>Load Star Truck 1600, 1700</td> <td>Perkins 6.354</td> <td>1965-1970</td> </tr> <tr> <td></td> <td>Load Star Truck 1800</td> <td>Perkins 6.354</td> <td>1965-1970</td> </tr> <tr> <td></td> <td>Pala meccanica H65</td> <td>Perkins 6.354.1</td> <td>-</td> </tr> <tr> <td></td> <td>Pala meccanica JH60, H65</td> <td>Perkins 6.354</td> <td>-</td> </tr> <tr> <td>J.C.B.</td> <td>Escavatore 7, 7C, 8</td> <td>Perkins 6.354</td> <td>-</td> </tr> </table>	ACMAT	Applic. diverse	Perkins 6.354	-	ALLIS-CHALMERS (USA)	4000 Applic. diverse	Perkins 6.288, 6.305	1965...		Tr. T1545	Perkins 6.354	-	ARBOS	Applic. diverse	Perkins 6.354	-	ATKINSON	L 1 266 PT	Perkins 6.354	-	AVELING BARFORD	Dump Truck RD017	Leyland 680, 690	11/1973...		Tr. AMIOOA	Perkins 6.354	-	BOLINDER MUNKTELL	5950	Perkins 6.354	1965-1970	BRAUD	505	Perkins 6.354, TG.354.1	-	BROOME & WADE	Compressore CR/CV 250	Perkins 6.354	-	BROYT	Escavatore	Perkins 6.354	-	CATERPILLAR	V160/300	Perkins 6.354	-	CLARK	Fork Tractor	Perkins 6.354	1966...		Tractor 45B	Perkins 6.354	-	DENNIS	Dart	Perkins 6.354	-	DOUGLAS	Tractive Units NS8/250	Leyland 680, 690	-		Tugmaster	Perkins 6.354	-	DRONNINGBORG	D1600	Perkins 6.354	-	HEATHFIELD	Dump Truck H20	Leyland 690	-	HYDROMAC	Escavatore 580	Perkins 6.354	-	HYSTER	Fork Truck H150, H250	Perkins 6.354, 6.354.1	-		Fork Truck HB100,H100C,RC150	Perkins 6.305.1	-		M300	Perkins 6.354, 6.354.1	-	IMC	C1600, C1800	Perkins 6.354	-	INGERSOLL	Compressore DRF 250	Perkins 6.354	-	INTERNATIONAL HARV.	Load Star Truck 1600, 1700	Perkins 6.354	1965-1970		Load Star Truck 1800	Perkins 6.354	1965-1970		Pala meccanica H65	Perkins 6.354.1	-		Pala meccanica JH60, H65	Perkins 6.354	-	J.C.B.	Escavatore 7, 7C, 8	Perkins 6.354	-
ACMAT	Applic. diverse	Perkins 6.354	-																																																																																																																								
ALLIS-CHALMERS (USA)	4000 Applic. diverse	Perkins 6.288, 6.305	1965...																																																																																																																								
	Tr. T1545	Perkins 6.354	-																																																																																																																								
ARBOS	Applic. diverse	Perkins 6.354	-																																																																																																																								
ATKINSON	L 1 266 PT	Perkins 6.354	-																																																																																																																								
AVELING BARFORD	Dump Truck RD017	Leyland 680, 690	11/1973...																																																																																																																								
	Tr. AMIOOA	Perkins 6.354	-																																																																																																																								
BOLINDER MUNKTELL	5950	Perkins 6.354	1965-1970																																																																																																																								
BRAUD	505	Perkins 6.354, TG.354.1	-																																																																																																																								
BROOME & WADE	Compressore CR/CV 250	Perkins 6.354	-																																																																																																																								
BROYT	Escavatore	Perkins 6.354	-																																																																																																																								
CATERPILLAR	V160/300	Perkins 6.354	-																																																																																																																								
CLARK	Fork Tractor	Perkins 6.354	1966...																																																																																																																								
	Tractor 45B	Perkins 6.354	-																																																																																																																								
DENNIS	Dart	Perkins 6.354	-																																																																																																																								
DOUGLAS	Tractive Units NS8/250	Leyland 680, 690	-																																																																																																																								
	Tugmaster	Perkins 6.354	-																																																																																																																								
DRONNINGBORG	D1600	Perkins 6.354	-																																																																																																																								
HEATHFIELD	Dump Truck H20	Leyland 690	-																																																																																																																								
HYDROMAC	Escavatore 580	Perkins 6.354	-																																																																																																																								
HYSTER	Fork Truck H150, H250	Perkins 6.354, 6.354.1	-																																																																																																																								
	Fork Truck HB100,H100C,RC150	Perkins 6.305.1	-																																																																																																																								
	M300	Perkins 6.354, 6.354.1	-																																																																																																																								
IMC	C1600, C1800	Perkins 6.354	-																																																																																																																								
INGERSOLL	Compressore DRF 250	Perkins 6.354	-																																																																																																																								
INTERNATIONAL HARV.	Load Star Truck 1600, 1700	Perkins 6.354	1965-1970																																																																																																																								
	Load Star Truck 1800	Perkins 6.354	1965-1970																																																																																																																								
	Pala meccanica H65	Perkins 6.354.1	-																																																																																																																								
	Pala meccanica JH60, H65	Perkins 6.354	-																																																																																																																								
J.C.B.	Escavatore 7, 7C, 8	Perkins 6.354	-																																																																																																																								



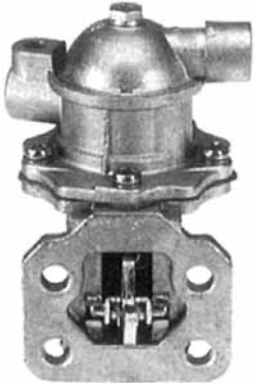

PUMP	PTZ number	original number	application
	6068	1.518.007 1.518.009 8.500.128	VM Industriale 295 a derivati ...1980 Industriale 395 a derivati ...1980
	6069	00605 2273000 1.518.0015A 1.518.0015E 1.518.014 1.518.015 60522730 PON 111	ALFA ROMEO Alfa 6 2500 Turbodiesel Alfa 75 2000 Turbodiesel Alfa 90 2400 Turbodiesel ALFA ROMEO Alfa 6 2500 Turbodiesel ALFA ROMEO Alfa 75 2000 Turbodiesel ALFA ROMEO Alfa 90 2400 Turbodiesel RAYTON-FISSORE Magnum 4x4 Turbodiesel VM Turbodiesel , TOYOTA Land Cruiser BJ73LV VM Turbodiesel VENIERI Pala meccanica 92A/3 VM HR 494 HPT VM Industriale HR 488,HR 488H,HR 488HT Industriale HR 588,HR 588H,HR 588HT Industriale HR 692H Industriale M 494HID-H-HT
	6070	AC-U F 7950622 Austin 12 H 180 12 H 195	AUSTIN A 60 Cambridge (1-5 L - Diesel '62/'65) BRITISH LEYLAND COMMERCIAL J 2 Van - Diesel '60/'66 152 Truck - Coach - Omnivar '58/'65 SAVA (Spagna) J 004 (allestimenti diversi)
	6072	461-114 7950454 708294/893	INTERNATIONAL HARVESTER BD 144 Diesel Eng. BD 154 Diesel Eng. B 275 Tractor- Diesel B 414 Tractor B 434 Tractor- Diesel B 450 Wheel Tractor
	6073	XP 111	AUSTIN MORRIS J4, 250 JU, petrol '67/'74

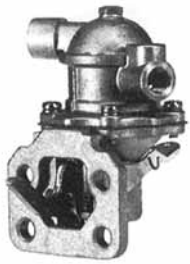

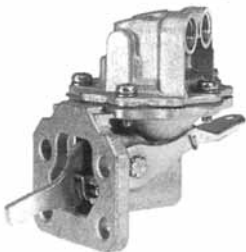
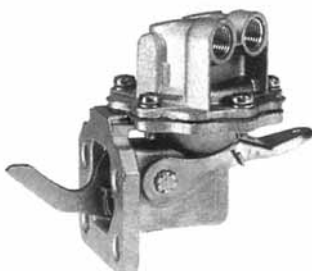

PUMP	PTZ number	original number	application			
	6074	3969 461-66 5507919 AR77914 AR92777 CX-020 DD13483 DE16748 EP1700 Ep66 RE37482	JOHN DEERE (EUROPA) Industriale 1120,1130,1140,1630,1640 ...1989 Industriale 1830,1840,2020,2030,20405 ...1989 Industriale 2120,2130,2140,3030,3040 ...1989 Industriale 3120,3130,3140,3640,40405 ...1989 Industriale 3, 4, h Cil. Diesel ...1989 Industriale 940, 1020,1030,1040 ...1989			
	6075	25061527 25066025 3851 461-181 536146 563146 1971192 AH-011 /1 PON 107	ROVER 110 2300 Diesel 1983-1984 88 & 109 IIA 21/4 L.Diesel (Suffix K) 1961-1971 88 & 109 III 2 1 /4 lit. Diesel - SANTANA Land Rover 90,110 2500 Diesel DC-DL -			
	6076	IMSA AK 0620101 994102	IMSA Mot. Perkins 4.99 y 4.108			
	6077	7950108	TR 2 4A mot. Perkins			
	6078	25061503 3852 3853 461-113 501735 549761 7950446 POC 622 PON 104	ROVER 110 2200 1983-1985 88 & 109 Serie IIA Petrol 21/4 1971-1984 88 & 109 Serie III 6 Cil. Petrol 21/4 1971-1984			
	6079	25062638 6 201 102 7 133 973 904F9350 AB 914F9350 AA 93151848 954F9350 AB LM-080	FORD TRANSIT FSD 425 2,5 L.Turbodiesel -			



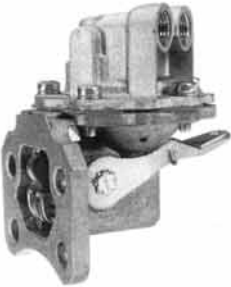

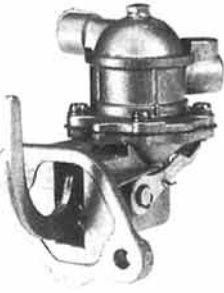

PUMP	PTZ number	original number	application
	6081	05042263	ACMAT Applic. diverse Perkins 6.354
		25061495	AILIS-CHALMERS (USA) 4000 Applic. diverse Perkins 6.286, 6.305 1965...
		25066409	Tr. T1545 Perkins 6.354
		2641372	ARBOS Applic. diverse Perkins 6.354
		2641374	ATKINSON L 1 266 PT Perkins 6.354
		2641375	AVELING BARFORD Dump Truck RD017 Leyland 680, 690 11 /1973...
		2641377	Tr. AM100A Perkins 6.354
		34167	BOLINDER MUNKTELL 5950 Perkins 6.354 1965-1970
		3679325	BRAUD 505 Perkins 6.354, T6.354.1
		461-131	BROOME & WADE Compresse CR/CV 250 Perkins 6.354
		461-132	BROYT Escavatore Perkins 6.354
		461-133	CATERPILLAR V160/300 Perkins 6.354
		461-135	CLARK Fork Tractor Perkins 6.354 1966...
		5043611	Tractor 45B Perkins 6.354
		6637508	DENNIS Dart Perkins 6.354
		781113	DOUGLAS Tractive Units NS8/250 Leyland 680, 690
		7950598	Tugmaster Perkins 6.354
		7950730	DRONNINGBORG D1600 Perkins 6.354
		7950764	HEATHFIELD Dump Truck H20 Leyland 690
		7950765	HYDROMAC Escavatore 580 Perkins 6.354
		X7950766	I HYSSTER Fork Truck H150, H250 Perkins 6.354, 6.354.1
		7950768	Fork Truck HB100, H100C, RC150 Perkins 6.305.1
		AR 2609	M300 Perkins 6.354, 6.354.1
		AK-096	IHC C1600, C1800 Perkins 6.354
		D34265	INGERSOLL Compresse DRF 250 Perkins 6.354
		FP133	INT. HARVESTER Load Star Truck 1600, 1700 Perkins 6.354 1965-1970
		PON	Load Star Truck 1800 Perkins 6.354 1965-1970
		112	Pala meccanica H65 Perkins 6.354.1
			Pala meccanica JH60, H65 Perkins 6.354
			J.C.B. Escavatore 7, 7C, 8 Perkins 6.354
			J.C.B. Escavatore 807 Perkins 6.354
			Mocchine agricole 413 Perkins 6.354
			Macchine agricole 418 Perkins T6.354
			Tr.112 Perkins 6.354.1
			Tr.114 Hydrostatic Perkins T6.354.1
			Tr. 808 Perkins 6.354
			IANCER BOSS Applic. diverse Perkins 6.354
			LANDINI Tr. MF 1104, 89500 Perkins 6.354.1
			Tr. TL 19N/A, 89500 Perkins 6.354.1, A6.354.1
			LAVERDA Mietitrebbiatrice Perkins 6.354, 6.372
			LEYLAND-ROVER Boxer PerL.h.354(Pompa2fori) 1972...
			Bus Atlantean FE30 680, 690 Perkins 6.354
			Bus BX1200, BX1300, BX1425 Perkins 6.354
			Bus Mastiff Perkins 6.354.2
			Scammell Routeman 680
			Worldmaster 680, 690
			MARSHALL Tr. TM90 Perkins 6.354
			MASSEY FERGUSON Escavatore 450C Perkins 6.354/1
			Escavat. MF 5400,620/5,3366 Perkins 6A/354
			Model 500 Combine -
	Tr. D400C, 4 Ruote motrici -		
	Tr. MF 1200, 4 Ruote motrici -		
	Tr. MF 400X/D, 507, 520, 525 -		
	Tr. MF 500, 507, 525 Perkins 6.354		
	MUIRHILL Macchine agricole 5000 Perkins 6.354		
	PERKINS Industriale (Diversi) 6.354, 6.372 1961...		
	Marino 4/99Mar.6.288, Perkins 6.354 1963...		
	SAVIEM (RVU Autoco<no 5800, 51000 Perkins 6.354		
	SEDDON ATKINSON Truck MK313/4 Perkins 6.354.2 1964-1976		
	SISU (VALMET) Truck 8141, 8142, 8149, M169 Leyland 690		
	S.O.S. Industriale Perkins 6.354		
	TALBOT 407 7 & 8 Ton Perkins 6.354 - 1965...		
	Dodge 3,5/5/6 Ton F/C Perkins 6.354 1965...		
	Dodge 6/7/8/9,5/10/11/12 Perkins 6.354 1963...		
	Dodge Bus Light/Heavy Perkins 6.354 1964...		
	Dodge C/D500, C/D600 "S" Perkins 6.354 1961...		
	Dodge D405 3,5 8 5 Ton Perkins 6.305 1965-1970		
	Dodge D406, DS00 Perkins 6.305, 6.354 1965...		
	Karrier VA,VB Truck 8/12 Ton Perkins 6.354 1963...		
	Karrier VC Truck 8/12 Ton Perkins 6.354 1963...		
	Serie G Commando (100) Perkins 6.354 1965...		
	Serie K (500) Perkins 6.354 1965-1978		
	WHITE ARBOS Combine Perkins 6.372		







PUMP	PTZ number	original number	application																																																																																																																																																			
	6082	25061460 461-54 5506951 17.20977.50 17.20977.51 816045 816071 POC 607 PON 121	<table border="0"> <tr> <td>BEDFORD</td> <td>Blitz 2100 CE Furgone</td> <td>Diesel Opel</td> <td>1978...</td> </tr> <tr> <td rowspan="3">OPEL</td> <td>Ascona, Rekord</td> <td>2000 Diesel</td> <td>1979-1981</td> </tr> <tr> <td>Ascona,Rekord,Rekord Turbod.</td> <td>-</td> <td>9/1972...</td> </tr> <tr> <td>Omega</td> <td>2300 Diesel</td> <td>8/1986...</td> </tr> <tr> <td></td> <td>Rekord E</td> <td>2100, 2300 Diesel</td> <td>1975-1986</td> </tr> <tr> <td></td> <td>Senator</td> <td>Turbodiesel</td> <td>1985...</td> </tr> <tr> <td>VAUXHALL</td> <td>Cadton</td> <td>Diesel 2300</td> <td>-</td> </tr> </table>	BEDFORD	Blitz 2100 CE Furgone	Diesel Opel	1978...	OPEL	Ascona, Rekord	2000 Diesel	1979-1981	Ascona,Rekord,Rekord Turbod.	-	9/1972...	Omega	2300 Diesel	8/1986...		Rekord E	2100, 2300 Diesel	1975-1986		Senator	Turbodiesel	1985...	VAUXHALL	Cadton	Diesel 2300	-																																																																																																																									
BEDFORD	Blitz 2100 CE Furgone	Diesel Opel	1978...																																																																																																																																																			
OPEL	Ascona, Rekord	2000 Diesel	1979-1981																																																																																																																																																			
	Ascona,Rekord,Rekord Turbod.	-	9/1972...																																																																																																																																																			
	Omega	2300 Diesel	8/1986...																																																																																																																																																			
	Rekord E	2100, 2300 Diesel	1975-1986																																																																																																																																																			
	Senator	Turbodiesel	1985...																																																																																																																																																			
VAUXHALL	Cadton	Diesel 2300	-																																																																																																																																																			
	6083	484072 60208 72095 75064077 7990114 7990268 910602 994141 994142 AK-063 AK-063/0 AK-063/1 FP251 FP264 PL-1005	<table border="0"> <tr> <td>EPPLER BUXBAUM</td> <td>Combine</td> <td>Perkins 4.236</td> </tr> <tr> <td>HANOMAG</td> <td>Macchina Agricola 22C</td> <td>Perkins 4.248</td> </tr> <tr> <td>HOBART</td> <td>300/400A</td> <td>Perkins 4.236</td> </tr> <tr> <td>HYSTER</td> <td>Fork Truck H1 10/150F</td> <td>Perkins 4.236</td> </tr> <tr> <td>INGERSOLL</td> <td>DR125/140/150</td> <td>Perkins 4.236</td> </tr> <tr> <td rowspan="2">INTERNATIONAL HARVESTER</td> <td>Tr. 474</td> <td>Perkins 4.212</td> </tr> <tr> <td>Tr. 585</td> <td>Perkins 4.236</td> </tr> <tr> <td>JOHNSTON BROS</td> <td>Serie 400</td> <td>Perkins 4.236</td> </tr> <tr> <td>JONES CRANES</td> <td>04 Mobile Crane</td> <td>Perkins 4.236</td> </tr> <tr> <td>J.C.B.</td> <td>Macchine agricole 110</td> <td>Perkins 4.248</td> </tr> <tr> <td>LANCER BOSS</td> <td>Applic. diverse</td> <td>Perkins 4.236</td> </tr> <tr> <td rowspan="2">LANDINI</td> <td>Tr. MF 174,MF 184,MF194 23</td> <td>Perkins 4.236</td> </tr> <tr> <td>Tr. 86500, 86550, 87500</td> <td>Perkins 4.236</td> </tr> <tr> <td></td> <td>Tr. TL 20C</td> <td>Perkins 4.212</td> </tr> <tr> <td></td> <td>Tr. TL 20N/A, TL20DT</td> <td>Perkins 4.236</td> </tr> <tr> <td></td> <td>Tr. TL 23</td> <td>Perkins 4.248</td> </tr> <tr> <td>LANSING BAGNALL</td> <td>Applic. diverse</td> <td>Perkins 4.236</td> </tr> <tr> <td>LAVERDA</td> <td>Applic. diverse M92</td> <td>Perkins 4.236</td> </tr> <tr> <td>LINCOLN ELECTRIC</td> <td>Generat.Elet. 300 & 400 Amp.</td> <td>Perkins 4.236</td> </tr> <tr> <td>LINDNER</td> <td>Trattore</td> <td>Perkins 4.236</td> </tr> <tr> <td rowspan="2">MASSEY FERGUSON</td> <td>Escavatore MF 350,W350,MF487</td> <td>Perkins 4.248</td> </tr> <tr> <td>MF 11 Shovel Loader</td> <td>Perkins 4.248</td> </tr> <tr> <td></td> <td>MF 165 Combine</td> <td>Perkins 4.212</td> </tr> <tr> <td></td> <td>Tr. Industr. MF 30/50</td> <td>Perkins 4.212</td> </tr> <tr> <td></td> <td>Tr. MF 168 Narrow</td> <td>Perkins 4.236</td> </tr> <tr> <td></td> <td>Tr. MF 168,168 Mk III/168F</td> <td>Perkins 4.236</td> </tr> <tr> <td></td> <td>Tr. MF 175/175S,175/178</td> <td>Perkins 4.236</td> </tr> <tr> <td></td> <td>Tr. MF 178</td> <td>Perkins 4.248</td> </tr> <tr> <td></td> <td>Tr. MF 185,188, 194</td> <td>Perk.4.248 248UA71961...</td> </tr> <tr> <td></td> <td>Tr. MF 186 Combine</td> <td>Perkins 4.212</td> </tr> <tr> <td></td> <td>Tr. MF 206,307Comb.Harvester</td> <td>Perkins 4.236</td> </tr> <tr> <td></td> <td>Tr. MF 265, 274, 275</td> <td>Perkins 4.236</td> </tr> <tr> <td></td> <td>Tr. MF 285, 290</td> <td>Perkins 4.248</td> </tr> <tr> <td></td> <td>Tr. MF 300, 33</td> <td>Perkins 4.248</td> </tr> <tr> <td></td> <td>Tr. MF 50 Phase II Skid</td> <td>Perkins 4.212</td> </tr> <tr> <td></td> <td>Tr. MF 50, 50B Industr. TDL</td> <td>Perkins 4.236</td> </tr> <tr> <td></td> <td>Tr. MF 565, 575</td> <td>Perkins 4.236</td> </tr> <tr> <td></td> <td>Tr. MF 590</td> <td>Perkins 4.248</td> </tr> <tr> <td></td> <td>Tr. MF 600</td> <td>Perkins 4.236</td> </tr> <tr> <td></td> <td>Tr. MF 675, 690</td> <td>-</td> </tr> <tr> <td>PERKINS</td> <td>Industriale</td> <td>4.212, 4.236, 4.248</td> </tr> <tr> <td>ROSSI</td> <td>Macchine Agricole</td> <td>Perkins 4.236</td> </tr> <tr> <td>SCHLTER</td> <td>Trattore</td> <td>Perkins 4.236</td> </tr> <tr> <td rowspan="5">TALBOT</td> <td>Commer fommando Serie 100 RG</td> <td>Perkins 4.236</td> </tr> <tr> <td>Commer KC Walk Thru</td> <td>Perkins 4.236</td> </tr> <tr> <td>Dodge Commando 100 Ser.RG</td> <td>Perkins 4.236</td> </tr> <tr> <td>Dodge KC Walk Thru</td> <td>Perkins 4.236 236U5670..</td> </tr> <tr> <td>Walk Thru 50</td> <td>Perkins 4.236</td> </tr> <tr> <td>TOWMOTOR</td> <td>FLT, V100/120/140</td> <td>Perkins 4.236</td> </tr> <tr> <td rowspan="3">VOLVO</td> <td>Tractor P300, P830</td> <td>Perkins 4.236</td> </tr> <tr> <td>Tractor P827, T500, P838</td> <td>Perkins 4.236</td> </tr> <tr> <td>Truck F82,F83,G65,G80,F407</td> <td>Perkins 4.236</td> </tr> </table>	EPPLER BUXBAUM	Combine	Perkins 4.236	HANOMAG	Macchina Agricola 22C	Perkins 4.248	HOBART	300/400A	Perkins 4.236	HYSTER	Fork Truck H1 10/150F	Perkins 4.236	INGERSOLL	DR125/140/150	Perkins 4.236	INTERNATIONAL HARVESTER	Tr. 474	Perkins 4.212	Tr. 585	Perkins 4.236	JOHNSTON BROS	Serie 400	Perkins 4.236	JONES CRANES	04 Mobile Crane	Perkins 4.236	J.C.B.	Macchine agricole 110	Perkins 4.248	LANCER BOSS	Applic. diverse	Perkins 4.236	LANDINI	Tr. MF 174,MF 184,MF194 23	Perkins 4.236	Tr. 86500, 86550, 87500	Perkins 4.236		Tr. TL 20C	Perkins 4.212		Tr. TL 20N/A, TL20DT	Perkins 4.236		Tr. TL 23	Perkins 4.248	LANSING BAGNALL	Applic. diverse	Perkins 4.236	LAVERDA	Applic. diverse M92	Perkins 4.236	LINCOLN ELECTRIC	Generat.Elet. 300 & 400 Amp.	Perkins 4.236	LINDNER	Trattore	Perkins 4.236	MASSEY FERGUSON	Escavatore MF 350,W350,MF487	Perkins 4.248	MF 11 Shovel Loader	Perkins 4.248		MF 165 Combine	Perkins 4.212		Tr. Industr. MF 30/50	Perkins 4.212		Tr. MF 168 Narrow	Perkins 4.236		Tr. MF 168,168 Mk III/168F	Perkins 4.236		Tr. MF 175/175S,175/178	Perkins 4.236		Tr. MF 178	Perkins 4.248		Tr. MF 185,188, 194	Perk.4.248 248UA71961...		Tr. MF 186 Combine	Perkins 4.212		Tr. MF 206,307Comb.Harvester	Perkins 4.236		Tr. MF 265, 274, 275	Perkins 4.236		Tr. MF 285, 290	Perkins 4.248		Tr. MF 300, 33	Perkins 4.248		Tr. MF 50 Phase II Skid	Perkins 4.212		Tr. MF 50, 50B Industr. TDL	Perkins 4.236		Tr. MF 565, 575	Perkins 4.236		Tr. MF 590	Perkins 4.248		Tr. MF 600	Perkins 4.236		Tr. MF 675, 690	-	PERKINS	Industriale	4.212, 4.236, 4.248	ROSSI	Macchine Agricole	Perkins 4.236	SCHLTER	Trattore	Perkins 4.236	TALBOT	Commer fommando Serie 100 RG	Perkins 4.236	Commer KC Walk Thru	Perkins 4.236	Dodge Commando 100 Ser.RG	Perkins 4.236	Dodge KC Walk Thru	Perkins 4.236 236U5670..	Walk Thru 50	Perkins 4.236	TOWMOTOR	FLT, V100/120/140	Perkins 4.236	VOLVO	Tractor P300, P830	Perkins 4.236	Tractor P827, T500, P838	Perkins 4.236	Truck F82,F83,G65,G80,F407	Perkins 4.236
EPPLER BUXBAUM	Combine	Perkins 4.236																																																																																																																																																				
HANOMAG	Macchina Agricola 22C	Perkins 4.248																																																																																																																																																				
HOBART	300/400A	Perkins 4.236																																																																																																																																																				
HYSTER	Fork Truck H1 10/150F	Perkins 4.236																																																																																																																																																				
INGERSOLL	DR125/140/150	Perkins 4.236																																																																																																																																																				
INTERNATIONAL HARVESTER	Tr. 474	Perkins 4.212																																																																																																																																																				
	Tr. 585	Perkins 4.236																																																																																																																																																				
JOHNSTON BROS	Serie 400	Perkins 4.236																																																																																																																																																				
JONES CRANES	04 Mobile Crane	Perkins 4.236																																																																																																																																																				
J.C.B.	Macchine agricole 110	Perkins 4.248																																																																																																																																																				
LANCER BOSS	Applic. diverse	Perkins 4.236																																																																																																																																																				
LANDINI	Tr. MF 174,MF 184,MF194 23	Perkins 4.236																																																																																																																																																				
	Tr. 86500, 86550, 87500	Perkins 4.236																																																																																																																																																				
	Tr. TL 20C	Perkins 4.212																																																																																																																																																				
	Tr. TL 20N/A, TL20DT	Perkins 4.236																																																																																																																																																				
	Tr. TL 23	Perkins 4.248																																																																																																																																																				
LANSING BAGNALL	Applic. diverse	Perkins 4.236																																																																																																																																																				
LAVERDA	Applic. diverse M92	Perkins 4.236																																																																																																																																																				
LINCOLN ELECTRIC	Generat.Elet. 300 & 400 Amp.	Perkins 4.236																																																																																																																																																				
LINDNER	Trattore	Perkins 4.236																																																																																																																																																				
MASSEY FERGUSON	Escavatore MF 350,W350,MF487	Perkins 4.248																																																																																																																																																				
	MF 11 Shovel Loader	Perkins 4.248																																																																																																																																																				
	MF 165 Combine	Perkins 4.212																																																																																																																																																				
	Tr. Industr. MF 30/50	Perkins 4.212																																																																																																																																																				
	Tr. MF 168 Narrow	Perkins 4.236																																																																																																																																																				
	Tr. MF 168,168 Mk III/168F	Perkins 4.236																																																																																																																																																				
	Tr. MF 175/175S,175/178	Perkins 4.236																																																																																																																																																				
	Tr. MF 178	Perkins 4.248																																																																																																																																																				
	Tr. MF 185,188, 194	Perk.4.248 248UA71961...																																																																																																																																																				
	Tr. MF 186 Combine	Perkins 4.212																																																																																																																																																				
	Tr. MF 206,307Comb.Harvester	Perkins 4.236																																																																																																																																																				
	Tr. MF 265, 274, 275	Perkins 4.236																																																																																																																																																				
	Tr. MF 285, 290	Perkins 4.248																																																																																																																																																				
	Tr. MF 300, 33	Perkins 4.248																																																																																																																																																				
	Tr. MF 50 Phase II Skid	Perkins 4.212																																																																																																																																																				
	Tr. MF 50, 50B Industr. TDL	Perkins 4.236																																																																																																																																																				
	Tr. MF 565, 575	Perkins 4.236																																																																																																																																																				
	Tr. MF 590	Perkins 4.248																																																																																																																																																				
	Tr. MF 600	Perkins 4.236																																																																																																																																																				
	Tr. MF 675, 690	-																																																																																																																																																				
PERKINS	Industriale	4.212, 4.236, 4.248																																																																																																																																																				
ROSSI	Macchine Agricole	Perkins 4.236																																																																																																																																																				
SCHLTER	Trattore	Perkins 4.236																																																																																																																																																				
TALBOT	Commer fommando Serie 100 RG	Perkins 4.236																																																																																																																																																				
	Commer KC Walk Thru	Perkins 4.236																																																																																																																																																				
	Dodge Commando 100 Ser.RG	Perkins 4.236																																																																																																																																																				
	Dodge KC Walk Thru	Perkins 4.236 236U5670..																																																																																																																																																				
	Walk Thru 50	Perkins 4.236																																																																																																																																																				
TOWMOTOR	FLT, V100/120/140	Perkins 4.236																																																																																																																																																				
VOLVO	Tractor P300, P830	Perkins 4.236																																																																																																																																																				
	Tractor P827, T500, P838	Perkins 4.236																																																																																																																																																				
	Truck F82,F83,G65,G80,F407	Perkins 4.236																																																																																																																																																				







PUMP	PTZ number	original number	application		
	6087	264.1725	PERKINS		
	6089	ETC 4303 1.518.019	LAND ROVER VM	Rover 2400 - SD Turbo (VM) Mot. HR 388/92 H-HT HR 492-HT Leyland	
	6090	276.6585.030 276.6585.11 276.6585.30 6416.6585.07 6585.11 672.6585.030 9.06.232.11 AS-050 POC 105	LOMBARDINI TOMO VINKOVIÈ	Industriale Industriale Industriale	Diesel LDA 672, LDA 673 Diesel LDA 832, LDA 833 Diesel (Gr.5-7-9-10-11)
	6091	IMSA AK 0870101	FIAT SUPERMIRAFIORI	Mot. Perkins 4.99 - 4.108	
	6092	25061608 25066379 2641704 2641712 2641808 461-312 93151069 994183 994295 AK-083 AK-083/1 FP312	ATLAS COPCO BOLINDER MUNKTEIL BROOMS & WADE CONSOLIDATED PNEUMATIC DALE ELECTRIC EICHER HYDROVANE HYSTER INGERSOLL JOHNSTON BROS LANDINI LEYLAND-ROVER LINDNER MASSEY FERGUSON PERKINS	Compressore XA60 Macchina agricola T430 Compressore CAI, CATS Applic. diverse Generatore elettrico Tr. 3155, 3255, 3256 Compressore 85CFM Fork Truck S30/40C FLT Compressore 85 CFM" Compressore PI 40 WP Applic. diverse Tr. MF 244 Tr. TL 19C, TL 21 C Tr. 245 Tr. Transporter 5205 Tr.122 Tr. Ind. MF 2203-7, 2205-7 Tr. LC.M. Aprilia MF 100C Tr. MF 133,135 Tr. MF 135,135/2135 Tr. MF 148 Tr. MF 235, 245, 255 Tr. MF 550 Industriale	Perkins D3.152 Perkins D3.152





PUMP	PTZ number	original number	application																																												
	6093	2.4519.220.0 2.4519.230.0 2.4519.290.0	<table border="0"> <tr> <td>HURLIMANN</td> <td>Trattore H6160</td> <td>Same</td> <td>-</td> </tr> <tr> <td>LAMBORGHINI</td> <td>Tr.1056</td> <td>Same 6 cil.</td> <td>1979...</td> </tr> <tr> <td>SAME DEUTZ-FAHR GROUP</td> <td>Industriale</td> <td>-</td> <td>1979...</td> </tr> <tr> <td></td> <td>Tr. Condor Sincro 55</td> <td>-</td> <td>-</td> </tr> <tr> <td></td> <td>Tr. Bufalo 130</td> <td>6 Cil.</td> <td>1979...</td> </tr> <tr> <td></td> <td>Tr. Drago 120</td> <td>6 Cil.</td> <td>1979...</td> </tr> <tr> <td></td> <td>Tr. Panther 90</td> <td>5 Cil.</td> <td>1979...</td> </tr> <tr> <td></td> <td>Tr. Tiger 100</td> <td>5 Cil.</td> <td>1979...</td> </tr> </table>	HURLIMANN	Trattore H6160	Same	-	LAMBORGHINI	Tr.1056	Same 6 cil.	1979...	SAME DEUTZ-FAHR GROUP	Industriale	-	1979...		Tr. Condor Sincro 55	-	-		Tr. Bufalo 130	6 Cil.	1979...		Tr. Drago 120	6 Cil.	1979...		Tr. Panther 90	5 Cil.	1979...		Tr. Tiger 100	5 Cil.	1979...												
HURLIMANN	Trattore H6160	Same	-																																												
LAMBORGHINI	Tr.1056	Same 6 cil.	1979...																																												
SAME DEUTZ-FAHR GROUP	Industriale	-	1979...																																												
	Tr. Condor Sincro 55	-	-																																												
	Tr. Bufalo 130	6 Cil.	1979...																																												
	Tr. Drago 120	6 Cil.	1979...																																												
	Tr. Panther 90	5 Cil.	1979...																																												
	Tr. Tiger 100	5 Cil.	1979...																																												
	6094	461-165 7971038 7950540 12641406 2641406 6616798	<table border="0"> <tr> <td>AVELING BARFORD</td> <td>Road Roller G85 Perkins 3/152</td> <td></td> <td></td> </tr> <tr> <td>BOLINDER MUNKTELL</td> <td>Terrier Tractor Perkins 3/152 TA</td> <td></td> <td></td> </tr> <tr> <td>HYSTER</td> <td>Fork Truck S30/40C Perkins 3/152</td> <td></td> <td></td> </tr> <tr> <td>LANDINI</td> <td>4000, 5000 Perkins 3/152</td> <td></td> <td></td> </tr> <tr> <td>MARSHALL</td> <td>Road Roller Perkins D3/152</td> <td></td> <td></td> </tr> <tr> <td>MASSEY FERGUSON</td> <td>Model 135 Tractor Perkins A3/152</td> <td></td> <td>1965</td> </tr> <tr> <td></td> <td>Model 203 Perkins 3A/152</td> <td></td> <td>1960</td> </tr> <tr> <td></td> <td>Model 205 Perkins 3A/152</td> <td></td> <td>1960</td> </tr> <tr> <td></td> <td>135 Tractor - Eng. 152UA38570D Perkins 3/152</td> <td></td> <td>1965</td> </tr> <tr> <td>PERKINS</td> <td>3A/152 Bolinder Munktel Terrier Tractor</td> <td></td> <td></td> </tr> <tr> <td></td> <td>3A/152 Massey Ferguson 135 Tractor</td> <td></td> <td>1965</td> </tr> </table>	AVELING BARFORD	Road Roller G85 Perkins 3/152			BOLINDER MUNKTELL	Terrier Tractor Perkins 3/152 TA			HYSTER	Fork Truck S30/40C Perkins 3/152			LANDINI	4000, 5000 Perkins 3/152			MARSHALL	Road Roller Perkins D3/152			MASSEY FERGUSON	Model 135 Tractor Perkins A3/152		1965		Model 203 Perkins 3A/152		1960		Model 205 Perkins 3A/152		1960		135 Tractor - Eng. 152UA38570D Perkins 3/152		1965	PERKINS	3A/152 Bolinder Munktel Terrier Tractor				3A/152 Massey Ferguson 135 Tractor		1965
AVELING BARFORD	Road Roller G85 Perkins 3/152																																														
BOLINDER MUNKTELL	Terrier Tractor Perkins 3/152 TA																																														
HYSTER	Fork Truck S30/40C Perkins 3/152																																														
LANDINI	4000, 5000 Perkins 3/152																																														
MARSHALL	Road Roller Perkins D3/152																																														
MASSEY FERGUSON	Model 135 Tractor Perkins A3/152		1965																																												
	Model 203 Perkins 3A/152		1960																																												
	Model 205 Perkins 3A/152		1960																																												
	135 Tractor - Eng. 152UA38570D Perkins 3/152		1965																																												
PERKINS	3A/152 Bolinder Munktel Terrier Tractor																																														
	3A/152 Massey Ferguson 135 Tractor		1965																																												
	6095	461-287 25061588 7990486	<table border="0"> <tr> <td>SAVIEM</td> <td>SM5, SM6, SM7, SM8, S9 597 6 cyl.</td> <td></td> <td></td> </tr> </table>	SAVIEM	SM5, SM6, SM7, SM8, S9 597 6 cyl.																																										
SAVIEM	SM5, SM6, SM7, SM8, S9 597 6 cyl.																																														
	6096	602-40480	LISTER																																												
	6097	201.39670 201.45340	LISTER																																												





PUMP	PTZ number	original number	application
	6098	602.37260	LISTER
	6099	25061574 25066418 2641706 2641723 2641809 43/002 461-303 74800012-0 74800019-0 7990347 994275 AK-099/0	NISSAN (DATSUN) Ebro Patrol 2700 Diesel PMD 270 (SPAGNA) PERKINS All. Volkswagen 4.165 Industriale 4.165 (Spagna) VOLKSWAGEN Furgone 230/313 Diesel Perkins 4.165 Furgone LT280, LT31 D, LT350 Perkins 4.165
	6100	25061561 25066038 2641710 461-230 461-258 75063007 7990002 7990151 994193 AK-054 AK-054/0 AK-054/1 K0026306	MASSEY FERGUSON Tr. ME 1114,1134 - - PERKINS Industriale PG.354,6.354.2,T6.354.3 1974... TALBOT Commer Commando G.354, 6.354.2, T6.353 1974... Commer Commando G.354, 6.354.2, T6.354.3 - Commer VA Truck 8/12 Ton Perkt. G.354354U191486... 1965... Commer VB Truck 8/12 Ton Perkt. G.354-354U191486... 1965... Commer UC Truck 8/12 Ton Perkt. G.354-354U191486... 1965... Dodge Commando PG.354,6.354.2,T6.354.3 - Dodge D-K 500 Perkins T6.354.3 -
	6102	461.403	AUSTIN London Taxi (Fx4)
	6103	210 0087 213 4511 223 9550 415 0197 415 7603 4167698 4231021 4230566 7.15252.01 7.15252.50 7.15252.51 7.15252.52 K7 01 50-17 PON 120 UC 0150-17	KHD (DEUT7) Industriale B/F 3,4,5,6 I 912/913 W/T 1964... Industriale F2L912 3/1984... Industriale F3L 812 D,F3I 912/912 W 1964... Industriale F3L 913 - Industriale F4L 812 D,F4I 912/912 W 1964... Industriale F5I 912/912 W, 912 D 1964... Industriale F6L 812 D,F6I 912/912 W 1964... VM Industriale 104,106, 954, 956 SU - Industriale 1056, T1056SU, 6105 - Industriale T6105 SUN -







PUMP	PTZ number	original number	application
	6104	351.12150	LISTER
	6105	351.12151	LISTER
	6108	8969 RE38009	JOHN DEERE (Europa) Industriale 1120,1130,1140,1630,1640 1990... Industriale 1830,1840,2020,2030,2040S 1990... Industriale 2120,2130,2140,3030,3040 1990... Industriale 3120,3130,3140,3640,4040S 1990... industriale 3/4/6 Cyl. 1989... Industriale 940,1020,1030,1040 1990...
	6110	461.42 25061434	BERLIET mot. 420-30
	6111	296531	LISTER
	6112	201.39672	LISTER







PUMP	PTZ number	original number	application
	6113	201.39671	LISTER
	6116	201.45341	LISTER
	6117	201.45342	LISTER
	6118	13M6306 7950452 25061538 7971368 25066396 808087 461-211 FP211 7950116 IC-012 7950410 PON 116	LEYLAND-ROVER 350 FG, 360 2,2 Lit. Petrol 1970... EA - 1975... FG 350, FGK30, 5200 2,2 Lit. Petrol 1970... FGK30-60, FG350-360 4,0 Lit. Petrol - FG-FGK 30, 5200, 350FG 2,2 Lit. Diesel 1970-1974 Gypsy Diesel, EA 2,2 Lit. Diesel 1975... WF 360, 420, 600, 900 4,0 Lit. Petrol 1970... WFK30-40, WF360-420 2,2 Lit. Petrol - WFK30-40, WFK360-420 2,8 lit. Diesel 1970... WF-WFK 100 40K-461616... 4,0lit. Petrol 1970... WF-WFK 30, 40, 60 4,0 Lit. Petrol -
	6119	25061522 7950065 25066376 7950188 25066377 7950426 2641308 7971051 461-109 A24796 461-169 AE-00b/1 502E9350 AK-1 06 590E9350 FP109	DALE ELECTRIC Generatore elettrico Perkins D3.152 1968... FORD Industriale 4 Cil. P4250/51,P4347/48 - Industriale 4 Cil. Simms P4145/78, - Industriale 6 Cil. Simms P431 b, P4354 - Industriale 6 Cil. Simms P4353 80 HP - HUNSLET Trattore Perkins D3.152 - HYDROVANE Compressore 856T, CFM Perkins D3.152 - LANSING BAGNALL FLT Perkins D3.152 - MASSEY FERGUSON Tr. 122 Perkins 3.152 - PERKINS Industriale D3.152 - TOWMOTOR 560P FLT Perkins D3.152 -
	6120	25066408 2641722 2641722/3 2641A054 3860 461311 905828 93151022	BALKANCAR Impez Perkins 4.203.2 CATERPILLAR V40-60 C Perkins 4.203.2 CLARK C500V40-0bOPD Perkins 4.203.2 COVENTRY Mod. DA 2.5 Perkins 4.203.2 EATON 3, 4 Ton. Perkins 4.203.2 EICNER Tr. 3355, 3356 Perkins 4.203.2 FENWICK Applic. diverse Perkins 4.203.2 France HYSTER H60, 80C Perkins 4.203.2 MASSEY FERGUSON Tr. MF 155,158, 260, S60 Perkins D4.203 PERKINS Industriale 4.203.2 Industriale D4.203



PUMP	PTZ number	original number	application
	6121	A 514533/2 - 93151222 461.333 - 7990012	CAV Diesel injectors 514533/2
	6122	25061618 461.337 93151344 PON 106	LEYLAND-ROVER Sherpa 2,5 (Dise) - ROVER Land Rover 90/110 Diesel 2500 1984-5/88
	6123	461.338 - 25066053 - 93151348	LEYLAND Terrier
	6124	107.6585.080 107.6585.097 1285 0894	IMEF Miniescavatore HE145 Lombardini 3 cil. - Miniescavatore HE24 Lombardini 4 cil. - LIGIER 162 GL Lombardini 2 cil. 500cc. LDW502 - LOMBARDINI Industriale LDW 1204T ...1995 Industriale LDW 502, 602, 903, 1204 - Industriale LDW BF4M, F4M, F3M ...1995
	6125	572.72120 - 7950841 1461.146 - 25061513	LISTER HL4, HL6, HLT6
	6126	1275.235	LISTER AC1, AD1, AC2, AD2



PUMP	PTZ number	original number	application
	6129	461.272 - 25061573 - 7990335	MG ROVER MGB 3500 3500, Range Rover
	6130	461.299 - 25061565 - 7990262	PETTERS PH, PJ
	6134	344.183 - 7990261 461.262 - 25061564	LISTER ABW, AC1 W, AC2, AC2W 2 bolt YJ
	6135	757.14173	LISTER LPW2, LPW3, LPW4 Marine engines

PUMP	PTZ number	original number	application
	6143	5042232 - 2641345 - 25061512 461.138 - 7950771	<p>BALKANCAR 2/4 Ton 4.203 Perkins dal ' 65 BUHRER Tractors D4.203 Perkins CHRYSLER Commer Bantam 4.203 Perkins KC Walk Thru 1.5/2/3 Ton (cyl. Petr.) Eng. 126069351 KC Walk Thru 4.203 Perkins Diesel Dodge KC Walk - Thru 4.203 Perkins Karrier Bantam MKV 4.203 Perkins</p> <p>CONVEYANCER TC Series 8 4.203 Perkins COVENTRY CLIMAX FLT 4.203 Perkins EATON VELBERT 2/4 Ton 4.203 Perkins HIDROMAC Hidraulic Excavator D4.203 Perkins</p> <p>HYSTER Fork Truck H60C, Karry Krane Ke 4.203.1 Perkins, Fork Truck KE Karry Crane, S60B/H60C FLT 4.203 Perkins Side Loader 4.203 Perkins 6000 4A, 192 & 4A.203 Perkins</p> <p>LANCER BOSS FLT 4.203 Perkins LANDINI CX65 4AD.236 Perkins LANSING BAGNALL MF 65 Tractor MK I & II MASSEY FERGUSON P4 & 4.203D Perkins Model 86-6 Combine 4AD.203 Perkins Model 165 Tractor AD4.203 Perkins P4 Massey Ferguson M65 Tractor 4.203 Massey Ferguson 65 Tractor MKII, 165 Tractor D4. 203 Industrial Applications</p>
	6144	461.113 - 25061502 - 7950446 549761 461.112 - 7950445 - 550324	<p>LANDROVER 88 & 109 Series IIA 2 1/4 Petrol, FC Diesel , 88 & 109 Series III 2 1/4 & 6 Cyl. Petrol</p>
	6145	2.4519.300.0	<p>SAME DEUTZ-FAHR GROUP Industriale 916.AW, 065.1600.0 - Tr. Explorer - - Tr. Frutteto 60 - -</p>
	6150	25061521 7950746 25061568 7971043 25066399 7990271 461-168 944997 461-267	<p>CASE Tr:1190,1290,1390,1490,1690 David Brown 1975... Tr: 580 David Brown -</p> <p>DAVID BROWN Tr: 1390, 1490,1690 - 1975,, Tr: 1x58, 1190, 1290 - 1974... Tr: 990,1200,1400 Serie 900 - 1974..</p> <p>ROVER 2000 SC, TC 2000 1965-1974 2200 2200 1972-1976</p>
	6151	123.00 00	<p>IMR MOTORI S46/T, TS46/T, - IMT 5100, 5106, 5130, 5136 -</p>

PUMP	PTZ number	original number	application
	6162	AC-FH 7950885 PERKINS 2641327 - 461.147	BEDFORD PERKINS
	6163	AC-HF 7971262 PERKINS 2641333 - 461.193	PERKINS
	6165		IMT 533
	6166		IMT 540, 560 TAM 2001
	6166+KO	120.00.00	IMT 539, 540, 560
	6167	124.00.00	TAM 75

PUMP	PTZ number	original number	application
	6173	125.00.00	DEUTZ TORPEDO 4506
	6175		DEUTZ TORPEDO
	6176		DEUTZ TORPEDO B/C 700
	6178		ALFA ROMEO 164 ROVER RANGE ROVER RANGE ROVER 2/4 PORTE RANGE ROVER 90, 110 ROVER 2400 SD TURBA VM INDUSTRIALE; HR 388, HR 388 H, HR 388 HT INDUSTRIALE; HR 392, HR 392 H, HR 392 HT INDUSTRIALE; HR 492 LEYLAND TAM TAM 90 (mot.VM) 1.518.0019A
	6179		DEUTZ TORPEDO
	6180	122.00.00	ZMAJ 132-133 Kombajn S44 motor Perkins IMT 577

PUMP	PTZ number	original number	application																
	<p>6181</p>	<p>3904374 3928143 610848 7971274 93151274 CBU 1099 FP274 J904374 RU-003</p>	<table border="0"> <tr> <td>CUMMINS</td> <td>Industriale</td> <td>Serie "B"</td> </tr> <tr> <td>DAF</td> <td>F 1000 CT Turbo</td> <td>Cummins 5,9 Lit. Diesel</td> </tr> <tr> <td>INTERNATIONAL HARVESTER</td> <td>Macchi. Lav.coltone 1822-2022</td> <td>Cummins 6TA 590</td> </tr> </table>	CUMMINS	Industriale	Serie "B"	DAF	F 1000 CT Turbo	Cummins 5,9 Lit. Diesel	INTERNATIONAL HARVESTER	Macchi. Lav.coltone 1822-2022	Cummins 6TA 590							
CUMMINS	Industriale	Serie "B"																	
DAF	F 1000 CT Turbo	Cummins 5,9 Lit. Diesel																	
INTERNATIONAL HARVESTER	Macchi. Lav.coltone 1822-2022	Cummins 6TA 590																	
	<p>6182</p>	<p>3928144</p>	<table border="0"> <tr> <td>CUMMINS</td> <td>Industriale</td> <td>-</td> </tr> </table>	CUMMINS	Industriale	-													
CUMMINS	Industriale	-																	
	<p>6183</p>		<table border="0"> <tr> <td>DINAMICA (Brasile)</td> <td>Industriale</td> <td>Perkins 4.236.2, 4.248</td> <td>-</td> </tr> <tr> <td>G.M.</td> <td>Pick Up D 10 (Brasile)</td> <td>Perkins 4236.2, 4.248</td> <td>...1985</td> </tr> <tr> <td>MASSEY FERGUSON</td> <td>Tr. MF 275, 290, 292 (Brasile)</td> <td>Perkins 4236.2, 4.248</td> <td>-</td> </tr> <tr> <td>PERKINS</td> <td>Industriale</td> <td>4.236.2, 4.248 (Brasile)</td> <td>-</td> </tr> </table>	DINAMICA (Brasile)	Industriale	Perkins 4.236.2, 4.248	-	G.M.	Pick Up D 10 (Brasile)	Perkins 4236.2, 4.248	...1985	MASSEY FERGUSON	Tr. MF 275, 290, 292 (Brasile)	Perkins 4236.2, 4.248	-	PERKINS	Industriale	4.236.2, 4.248 (Brasile)	-
DINAMICA (Brasile)	Industriale	Perkins 4.236.2, 4.248	-																
G.M.	Pick Up D 10 (Brasile)	Perkins 4236.2, 4.248	...1985																
MASSEY FERGUSON	Tr. MF 275, 290, 292 (Brasile)	Perkins 4236.2, 4.248	-																
PERKINS	Industriale	4.236.2, 4.248 (Brasile)	-																

PUMP	PTZ number	original number	application																																																																																				
	6504	25061542 25061585 25066382 25066388 461-217 461-261 461-314 4880294 508203-2 7971399 7990449 A504827 A512546/2 D8NN9350 AA D8NN9350 AB FP314 LM831637	<table border="0"> <tr> <td>BRISTOL</td> <td>LH Serie</td> <td>Leyland 401, 410</td> <td>-</td> </tr> <tr> <td>CAV</td> <td>Equipment Layland</td> <td>0E370, 400</td> <td>-</td> </tr> <tr> <td>FORD</td> <td>Trattore</td> <td>-</td> <td>-</td> </tr> <tr> <td>LEYLAND - ROVER</td> <td>BX1425, BX20F</td> <td>6/98 Turbo Diesel</td> <td>-</td> </tr> <tr> <td></td> <td>Boxer</td> <td>6/98 Turbo Diesel</td> <td>1973...</td> </tr> <tr> <td></td> <td>Buffalo</td> <td>500</td> <td>-</td> </tr> <tr> <td></td> <td>Bus Clydesdale ECD 23, ECD 27</td> <td>401</td> <td>-</td> </tr> <tr> <td></td> <td>Bus National</td> <td>502</td> <td>-</td> </tr> <tr> <td></td> <td>Bus Viking EVK 55</td> <td>401</td> <td>-</td> </tr> <tr> <td></td> <td>Carro Lynx 26T, 28T</td> <td>500</td> <td>1970...</td> </tr> <tr> <td></td> <td>Carro Octopus 30T</td> <td>502</td> <td>1971...</td> </tr> <tr> <td></td> <td>Carro Reiver</td> <td>401, 410</td> <td>1971...</td> </tr> <tr> <td></td> <td>Chieftain</td> <td>410 Turbo</td> <td>-</td> </tr> <tr> <td></td> <td>Clydesdale</td> <td>301</td> <td>-</td> </tr> <tr> <td></td> <td>Industriale</td> <td>400 con CAV</td> <td>-</td> </tr> <tr> <td></td> <td>Industriale</td> <td>400 (Simms P4654, P4692)</td> <td>-</td> </tr> <tr> <td></td> <td>Industriale</td> <td>500</td> <td>1971...</td> </tr> <tr> <td></td> <td>Tr. Bison</td> <td>500</td> <td>1970...</td> </tr> <tr> <td>SHELVOKE</td> <td>Intapak, PT Revopak</td> <td>Leyland 401, 410</td> <td>-</td> </tr> <tr> <td>SISU (VALTRA)</td> <td>BX8480 City Autotel. 500Turbo</td> <td>Leyland</td> <td>-</td> </tr> <tr> <td>VOLVO</td> <td>Loaders LM621, LM641, LM4300</td> <td>-</td> <td>1979...</td> </tr> </table>	BRISTOL	LH Serie	Leyland 401, 410	-	CAV	Equipment Layland	0E370, 400	-	FORD	Trattore	-	-	LEYLAND - ROVER	BX1425, BX20F	6/98 Turbo Diesel	-		Boxer	6/98 Turbo Diesel	1973...		Buffalo	500	-		Bus Clydesdale ECD 23, ECD 27	401	-		Bus National	502	-		Bus Viking EVK 55	401	-		Carro Lynx 26T, 28T	500	1970...		Carro Octopus 30T	502	1971...		Carro Reiver	401, 410	1971...		Chieftain	410 Turbo	-		Clydesdale	301	-		Industriale	400 con CAV	-		Industriale	400 (Simms P4654, P4692)	-		Industriale	500	1971...		Tr. Bison	500	1970...	SHELVOKE	Intapak, PT Revopak	Leyland 401, 410	-	SISU (VALTRA)	BX8480 City Autotel. 500Turbo	Leyland	-	VOLVO	Loaders LM621, LM641, LM4300	-	1979...
BRISTOL	LH Serie	Leyland 401, 410	-																																																																																				
CAV	Equipment Layland	0E370, 400	-																																																																																				
FORD	Trattore	-	-																																																																																				
LEYLAND - ROVER	BX1425, BX20F	6/98 Turbo Diesel	-																																																																																				
	Boxer	6/98 Turbo Diesel	1973...																																																																																				
	Buffalo	500	-																																																																																				
	Bus Clydesdale ECD 23, ECD 27	401	-																																																																																				
	Bus National	502	-																																																																																				
	Bus Viking EVK 55	401	-																																																																																				
	Carro Lynx 26T, 28T	500	1970...																																																																																				
	Carro Octopus 30T	502	1971...																																																																																				
	Carro Reiver	401, 410	1971...																																																																																				
	Chieftain	410 Turbo	-																																																																																				
	Clydesdale	301	-																																																																																				
	Industriale	400 con CAV	-																																																																																				
	Industriale	400 (Simms P4654, P4692)	-																																																																																				
	Industriale	500	1971...																																																																																				
	Tr. Bison	500	1970...																																																																																				
SHELVOKE	Intapak, PT Revopak	Leyland 401, 410	-																																																																																				
SISU (VALTRA)	BX8480 City Autotel. 500Turbo	Leyland	-																																																																																				
VOLVO	Loaders LM621, LM641, LM4300	-	1979...																																																																																				
	6511	910574 1447381 2641338 2641478 3637287 3726067 5082037 7480325 7971135 7990439 7990440 25061584 25066386 461-283 461-284 FP284 PAD 1209 SP078 SP079	<table border="0"> <tr> <td>JONES CRANES</td> <td>04 Mobile Crane</td> <td>Perkins 4.236</td> <td>-</td> </tr> <tr> <td>LANDINI</td> <td>Tr. 8000</td> <td>Perkins 4.248</td> <td>-</td> </tr> <tr> <td>LAVERDA</td> <td>Combine</td> <td>Perkins 4.236</td> <td>-</td> </tr> <tr> <td>MASSEY FERGUSON</td> <td>MF 11</td> <td>Perkins 4.248</td> <td>-</td> </tr> <tr> <td></td> <td>MF 165 Combine</td> <td>Perkins 4.212</td> <td>-</td> </tr> <tr> <td></td> <td>MF 186 Combine</td> <td>Perkins 4.212</td> <td>-</td> </tr> <tr> <td></td> <td>MF 487 Combine</td> <td>Perkins 4.248</td> <td>-</td> </tr> <tr> <td></td> <td>MF 50 Phase II Skid</td> <td>Perkins 4.212</td> <td>-</td> </tr> <tr> <td></td> <td>Macchina Agricola MF 33</td> <td>Perkins 4.248</td> <td>-</td> </tr> <tr> <td></td> <td>Tr. 168, MF175/175S, 175/178</td> <td>Perkins 4.236</td> <td>-</td> </tr> <tr> <td></td> <td>Tr. Industr. MF 30/50</td> <td>Perkins 4.212</td> <td>-</td> </tr> <tr> <td></td> <td>Tr. MF 178, 185, 188</td> <td>Perkins 4.248...248UA71960</td> <td>-</td> </tr> <tr> <td></td> <td>Tr. MF 300</td> <td>Perkins 4.248</td> <td>-</td> </tr> <tr> <td>PERKINS</td> <td>Industriale</td> <td>4.212, 4.236, 4.248</td> <td>-</td> </tr> <tr> <td>ROSSI</td> <td>Macchine Agricole</td> <td>Perkins 4.236</td> <td>-</td> </tr> <tr> <td>TALBOT</td> <td>Walk Thru 50</td> <td>Perkins 4.236</td> <td>-</td> </tr> <tr> <td>VOLVO</td> <td>Truck F82, F83</td> <td>Perkins 4.236</td> <td>-</td> </tr> </table>	JONES CRANES	04 Mobile Crane	Perkins 4.236	-	LANDINI	Tr. 8000	Perkins 4.248	-	LAVERDA	Combine	Perkins 4.236	-	MASSEY FERGUSON	MF 11	Perkins 4.248	-		MF 165 Combine	Perkins 4.212	-		MF 186 Combine	Perkins 4.212	-		MF 487 Combine	Perkins 4.248	-		MF 50 Phase II Skid	Perkins 4.212	-		Macchina Agricola MF 33	Perkins 4.248	-		Tr. 168, MF175/175S, 175/178	Perkins 4.236	-		Tr. Industr. MF 30/50	Perkins 4.212	-		Tr. MF 178, 185, 188	Perkins 4.248...248UA71960	-		Tr. MF 300	Perkins 4.248	-	PERKINS	Industriale	4.212, 4.236, 4.248	-	ROSSI	Macchine Agricole	Perkins 4.236	-	TALBOT	Walk Thru 50	Perkins 4.236	-	VOLVO	Truck F82, F83	Perkins 4.236	-																
JONES CRANES	04 Mobile Crane	Perkins 4.236	-																																																																																				
LANDINI	Tr. 8000	Perkins 4.248	-																																																																																				
LAVERDA	Combine	Perkins 4.236	-																																																																																				
MASSEY FERGUSON	MF 11	Perkins 4.248	-																																																																																				
	MF 165 Combine	Perkins 4.212	-																																																																																				
	MF 186 Combine	Perkins 4.212	-																																																																																				
	MF 487 Combine	Perkins 4.248	-																																																																																				
	MF 50 Phase II Skid	Perkins 4.212	-																																																																																				
	Macchina Agricola MF 33	Perkins 4.248	-																																																																																				
	Tr. 168, MF175/175S, 175/178	Perkins 4.236	-																																																																																				
	Tr. Industr. MF 30/50	Perkins 4.212	-																																																																																				
	Tr. MF 178, 185, 188	Perkins 4.248...248UA71960	-																																																																																				
	Tr. MF 300	Perkins 4.248	-																																																																																				
PERKINS	Industriale	4.212, 4.236, 4.248	-																																																																																				
ROSSI	Macchine Agricole	Perkins 4.236	-																																																																																				
TALBOT	Walk Thru 50	Perkins 4.236	-																																																																																				
VOLVO	Truck F82, F83	Perkins 4.236	-																																																																																				

Water

cooling pump



00100



00101



00102



00103



00105



00106



00107



00108



00109



00123



00125



00126



PTZ d.o.o.
Podhosta 12a
8350 Dolenjske Topljice
Slovenia / EU

www: www.ptz.si
e-mail: info@ptz.si

PTZ produces around 720 different types of classic membrane fuel pumps. Our program consists of diesel and gasoline pumps which can be made with or without our trade mark.

The pumps, we produce, are made by Italian technology from Torino and one-way filter for fuel is produced by technology developed in our own company.

Our technology provides 100% output control system, however the defected goods can be exchanged by guarantee.

Die Firma PTZ produziert caa 720 Typen von klassischen Membranpumpen, die Diesel und Benzinprogramm umfasst. Nach Wunsch koenen wir die Pumpen mit oder ohne unserer Firmennahme liefern.

Die Pumpen produzieren wir nach italiaenische Technologie aus Torino, Einwegkraftstofffilter aber war in unserer Firma entwickelt. 100 prozentige Kontrolle ist Zusammensetzung unserer Produktion. In Garantiefrist beschaedigte unsere Produkte tauschen wir kostenlos.

Alle Marke fuer die wir die Pumpen produzieren fiden sie in Katalog, hier in Prospekt und auf der Interentseite.

